

TS	Pos.	Stk.	Benennung	Profil	Material	Länge	Gewicht	Bem.
1	1006	1	Handlauf (Obergurt)	MSH50*25*2.5	ST37-2	6000	16.23	
1	1007	2	Köpfe Handlauf	BL2*20	45			
1	1009	5	Geländer	MSH40*3.2	ST37-2	760	13.79	
1	1011	5	Geländer	MSH40*3.2	ST37-2	114	2.07	
1	1012	56	Geländer Stäbe	MSH20*2	ST37-2	760	46.56	
1	1020	4	Köpfe Handlauf	BL2*20	ST37-2	45		
Gesamtgewicht (kg)							104.27	

Ansicht von links, A-A  
 2 x Pos. 1007  
 MSH50\*25\*2.5 - ST37-2..1650

Ansicht von links, A-A  
 1 x Pos. 1009  
 MSH40\*3.2 - ST37-2..760

Ansicht von links, A-A  
 1 x Pos. 1006  
 MSH50\*25\*2.5 - ST37-2..6000

Ansicht von links, A-A  
 5 x Pos. 1011  
 MSH40\*3.2 - ST37-2..114

Ansicht von links, A-A  
 1 x Pos. 1012  
 MSH20\*2 - ST37-2..760

Ansicht von links, A-A  
 5 x Pos. 1009  
 MSH40\*3.2 - ST37-2..760

Ansicht von links, A-A  
 1 x Pos. 1001  
 T80 - ST37-2..7670

Ansicht von links, A-A  
 10 x Pos. 1017  
 FL30\*8 - ST37-2..100

Ansicht von links, A-A  
 2 x Pos. 1016  
 FL70\*10 - ST37-2..200

Ansicht von links, A-A  
 2 x Pos. 1016  
 FL70\*10 - ST37-2..200

Ansicht von links, A-A  
 2 x Pos. 1016  
 FL70\*10 - ST37-2..200

Ansicht von links, A-A  
 2 x Pos. 1016  
 FL70\*10 - ST37-2..200

Ansicht von links, A-A  
 2 x Pos. 1016  
 FL70\*10 - ST37-2..200

Ansicht von links, A-A  
 2 x Pos. 1016  
 FL70\*10 - ST37-2..200

Ansicht von links, A-A  
 2 x Pos. 1016  
 FL70\*10 - ST37-2..200

Ansicht von links, A-A  
 2 x Pos. 1016  
 FL70\*10 - ST37-2..200

Ansicht von links, A-A  
 2 x Pos. 1016  
 FL70\*10 - ST37-2..200

Ansicht von links, A-A  
 2 x Pos. 1016  
 FL70\*10 - ST37-2..200

TS	Pos.	Stk.	Benennung	Profil	Material	Länge	Gewicht	Bem.
1	1	1	Längsträger vorne	IPE140	ST37-2	7670	98.94	

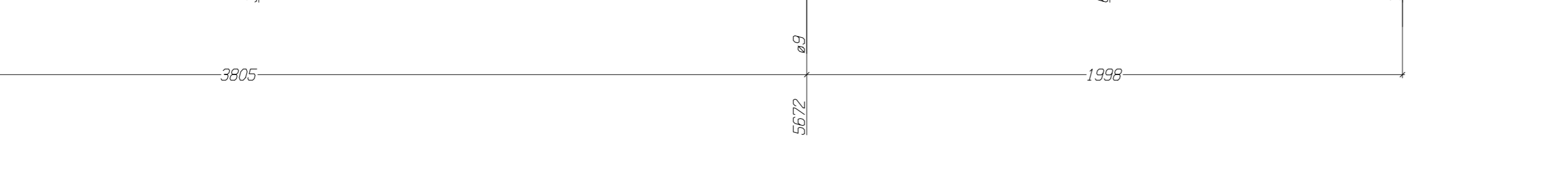
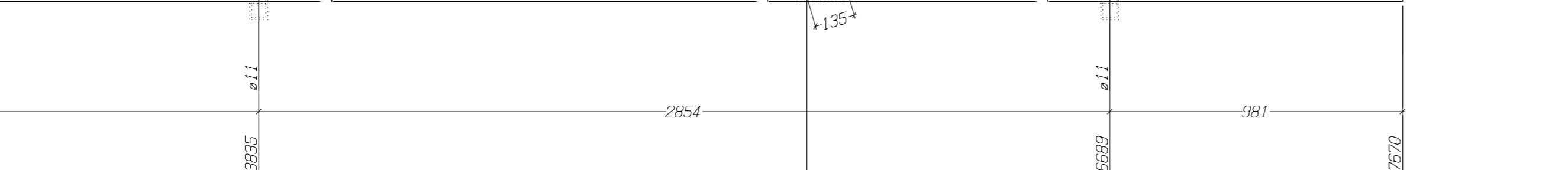
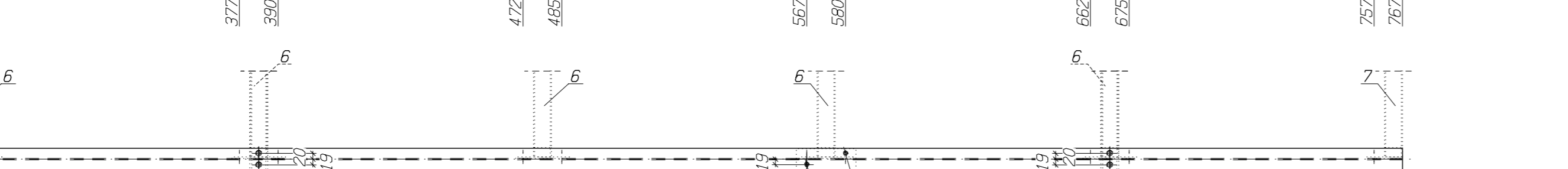
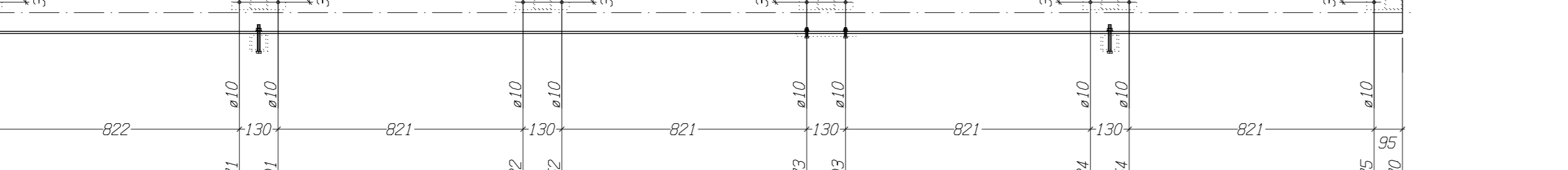
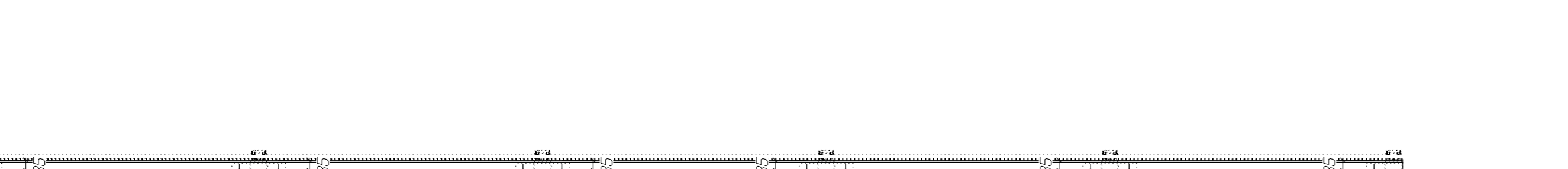
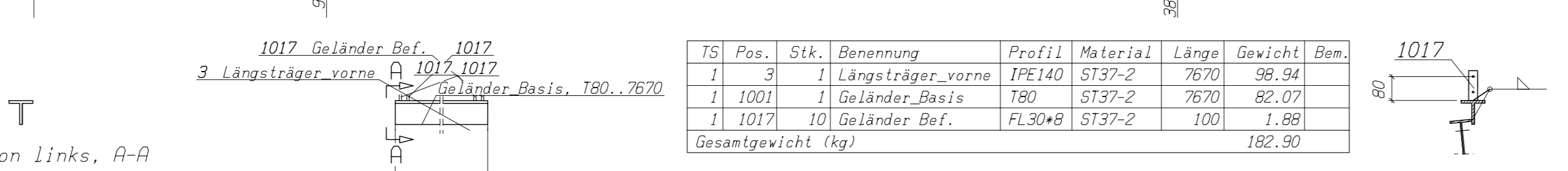
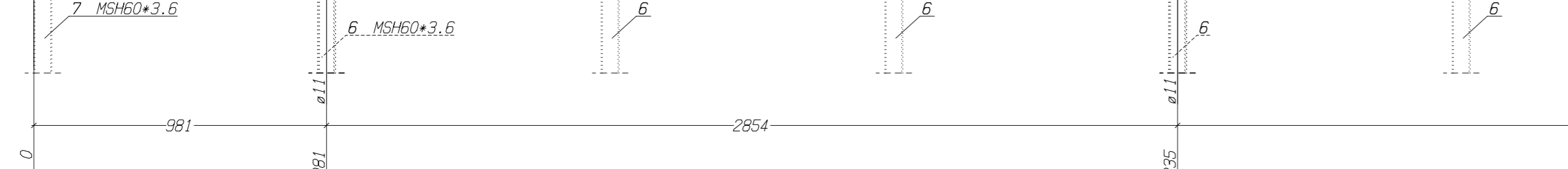
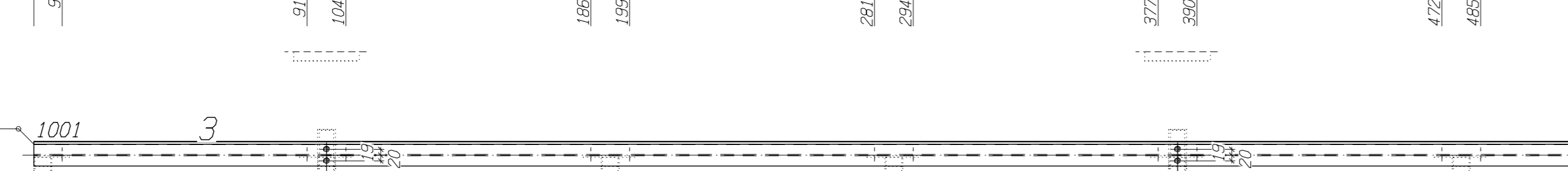
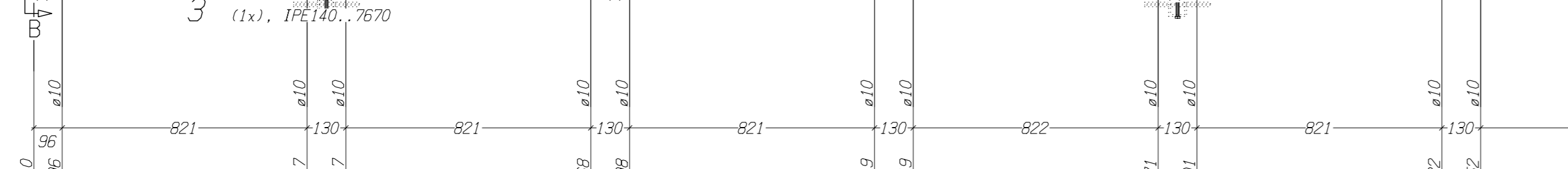
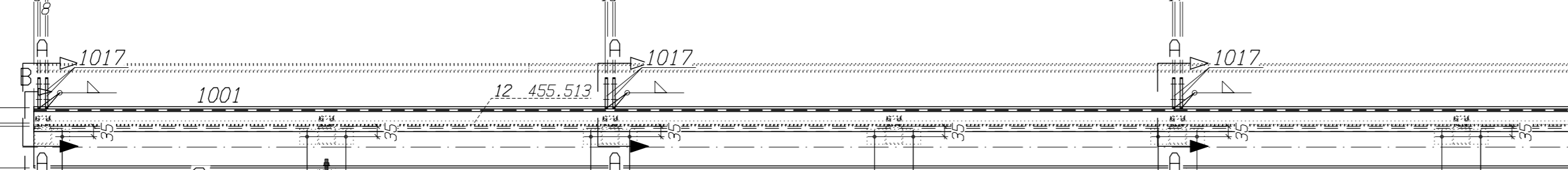
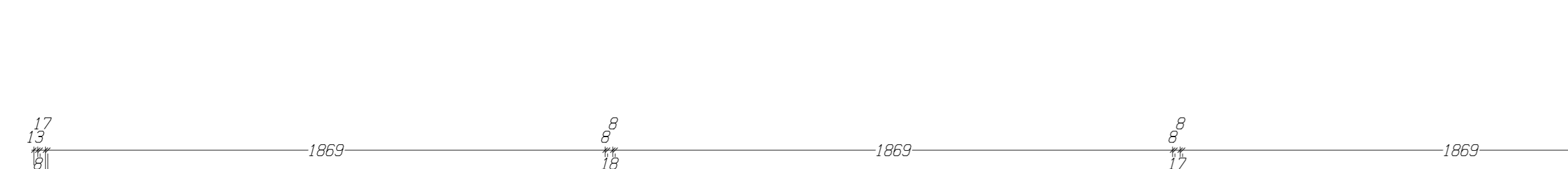
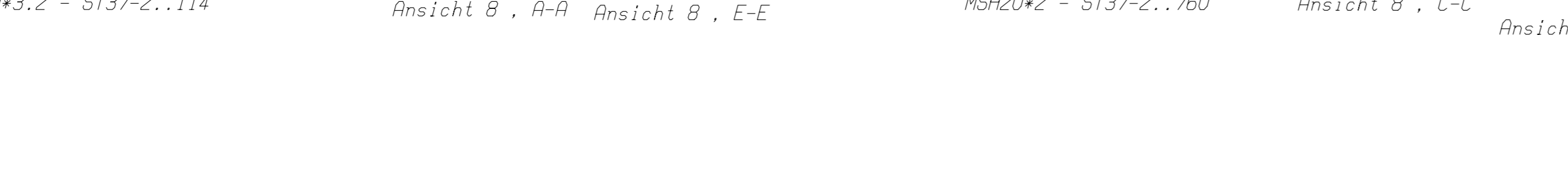
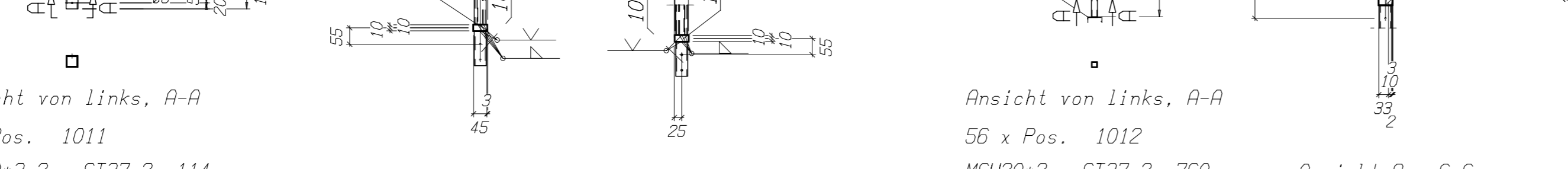
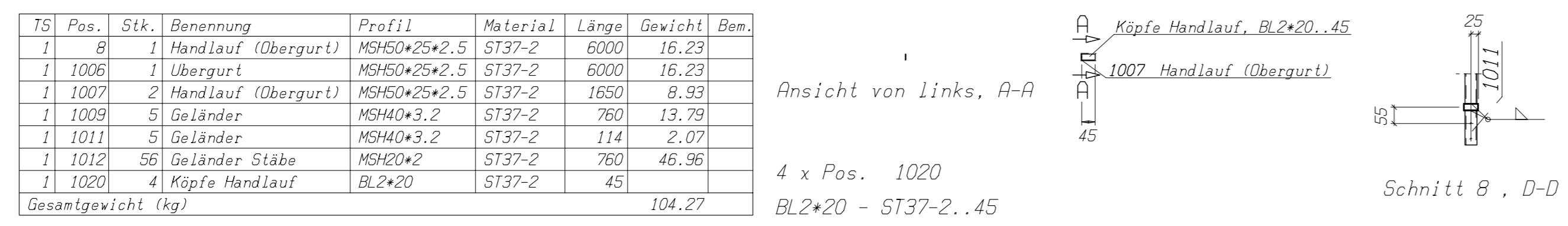

TS	Pos.	Stk.	Benennung	Profil	Material	Länge	Gewicht	Bem.
1	1	1	Längsträger vorne	IPE140	ST37-2	7670	98.94	

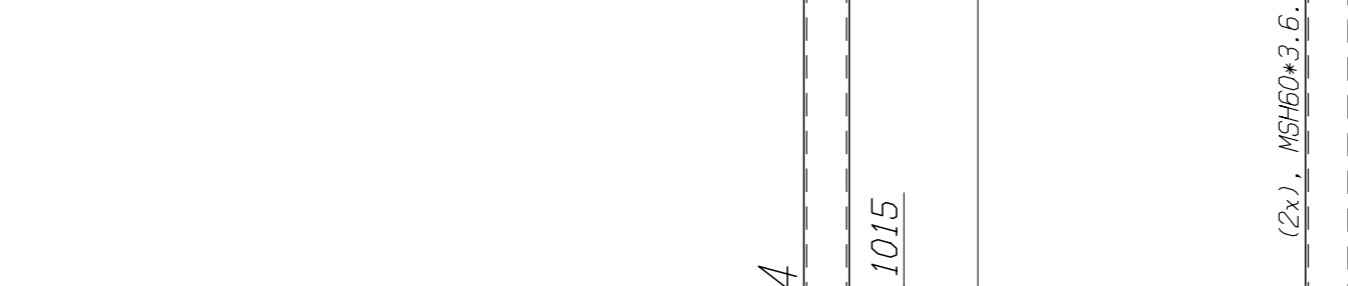
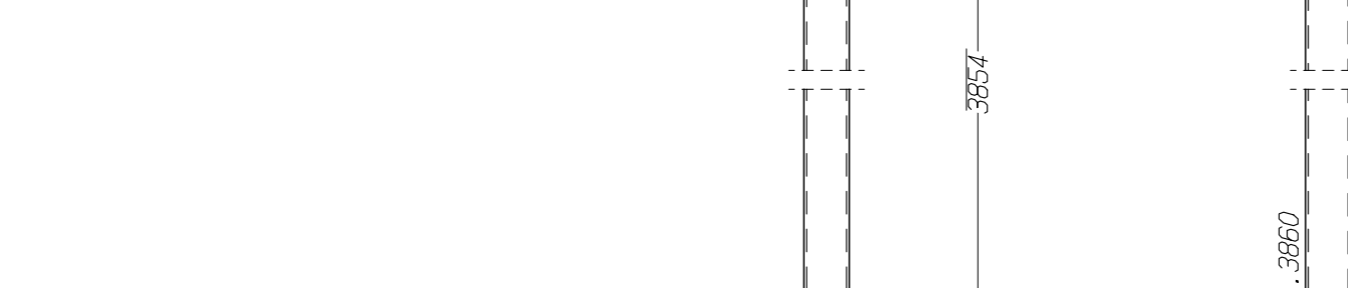
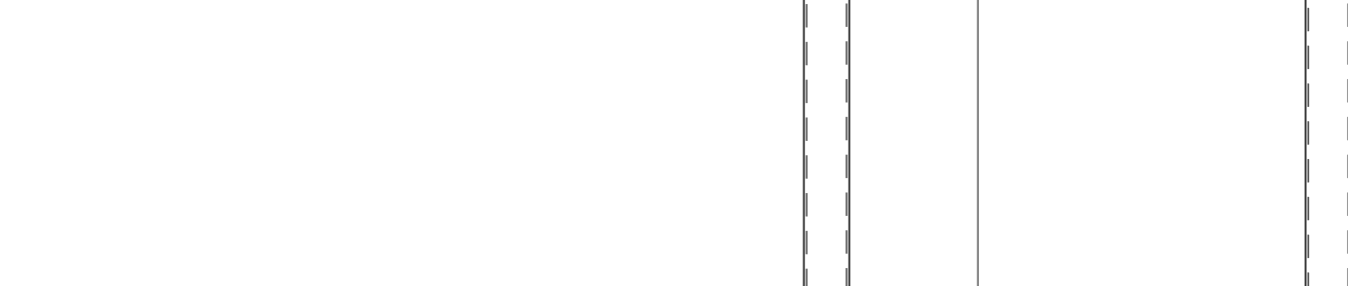
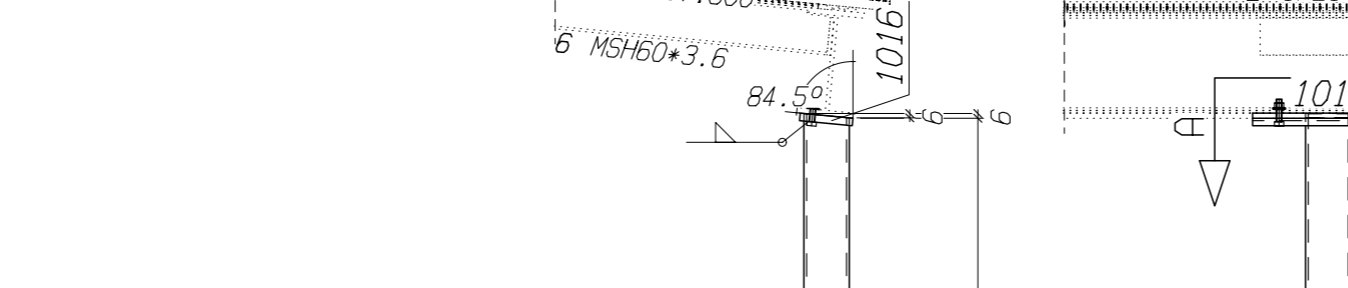
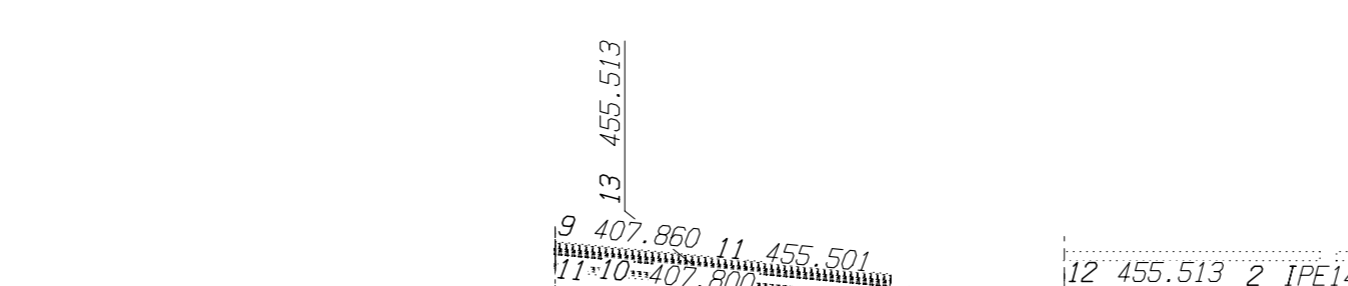
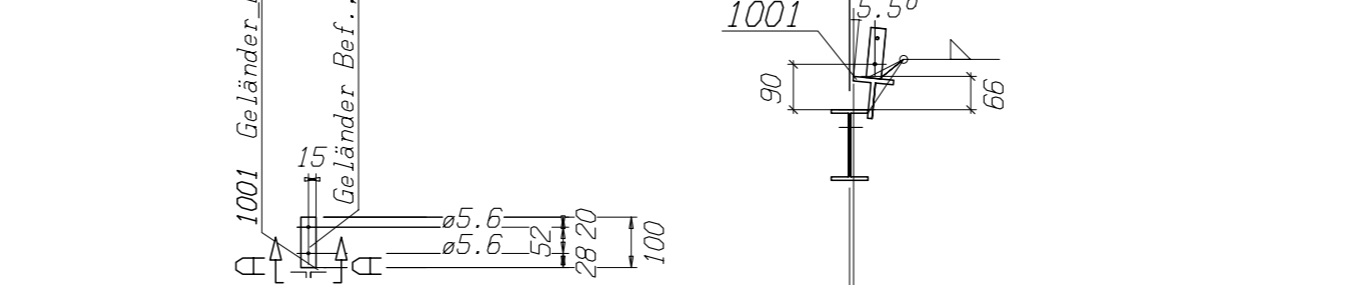
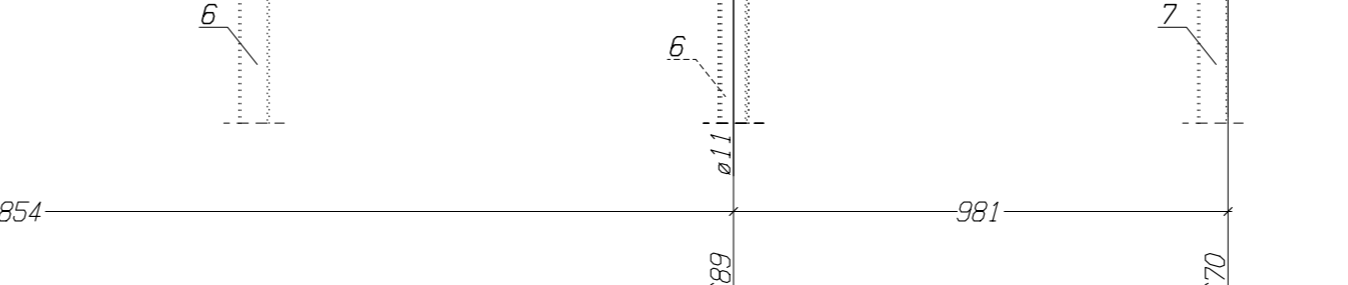
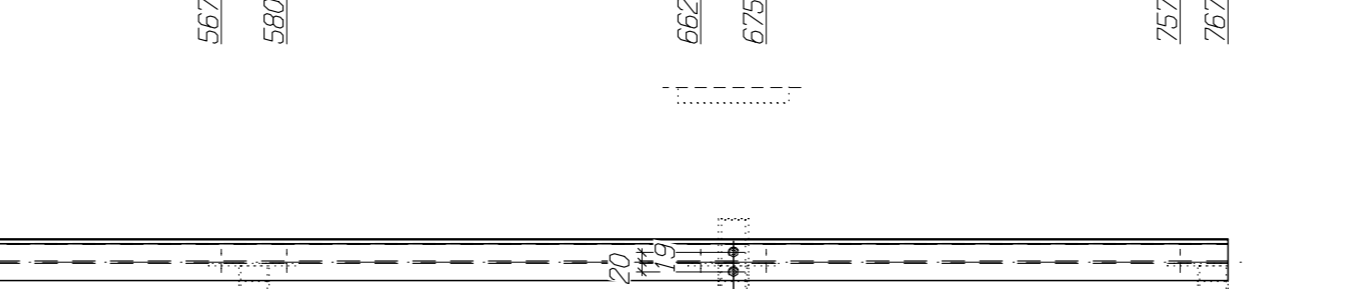
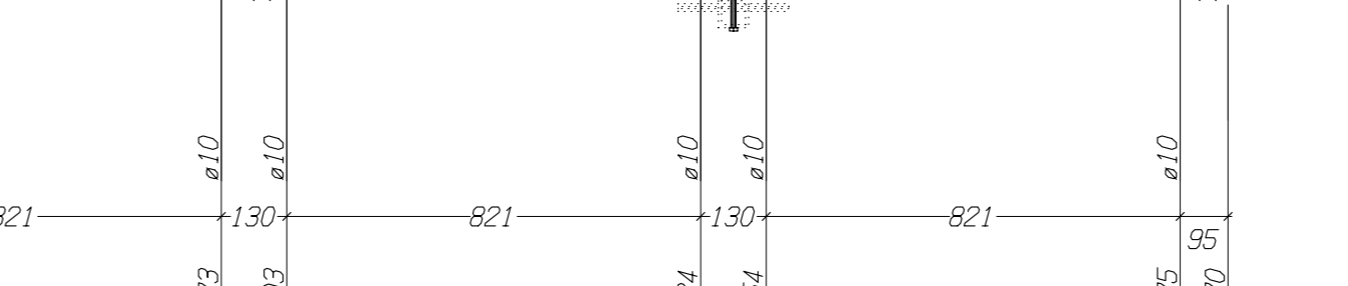
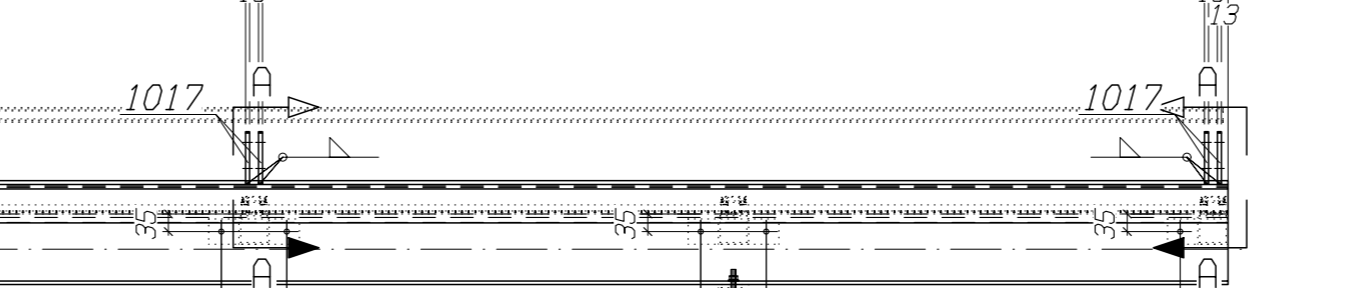

TS	Pos.	Stk.	Benennung	Profil	Material	Länge	Gewicht	Bem.
1	1	1	Längsträger vorne	IPE140	ST37-2	7670	98.94	

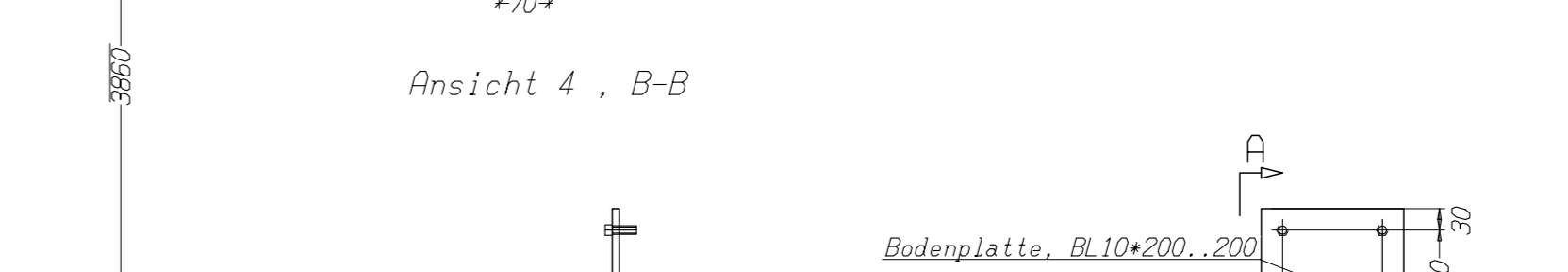
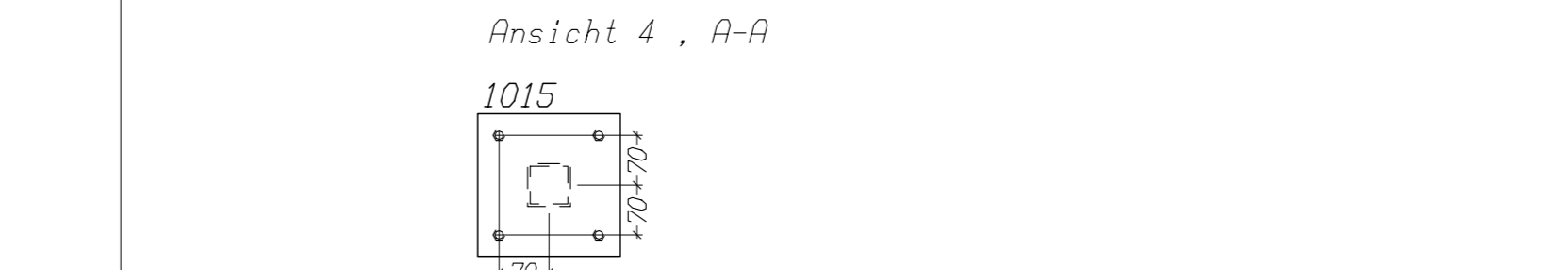
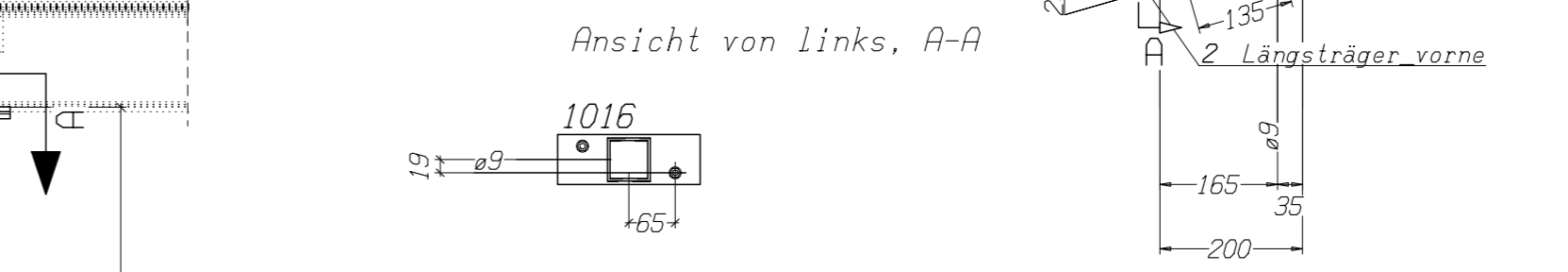
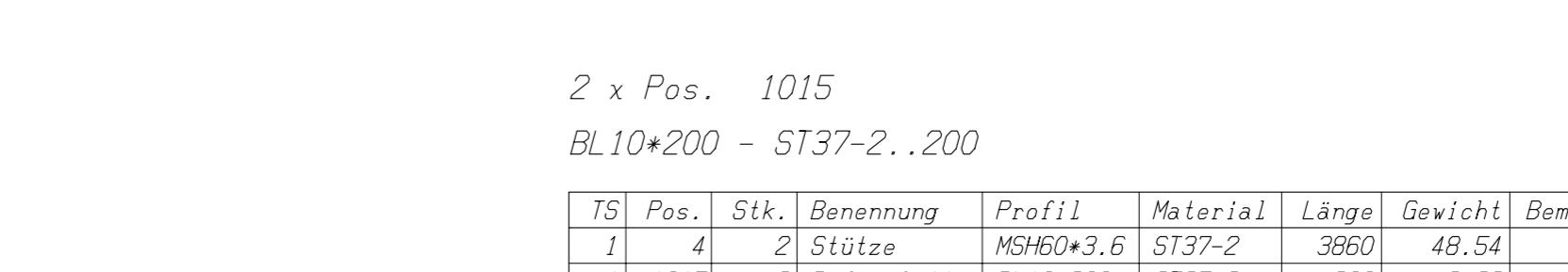
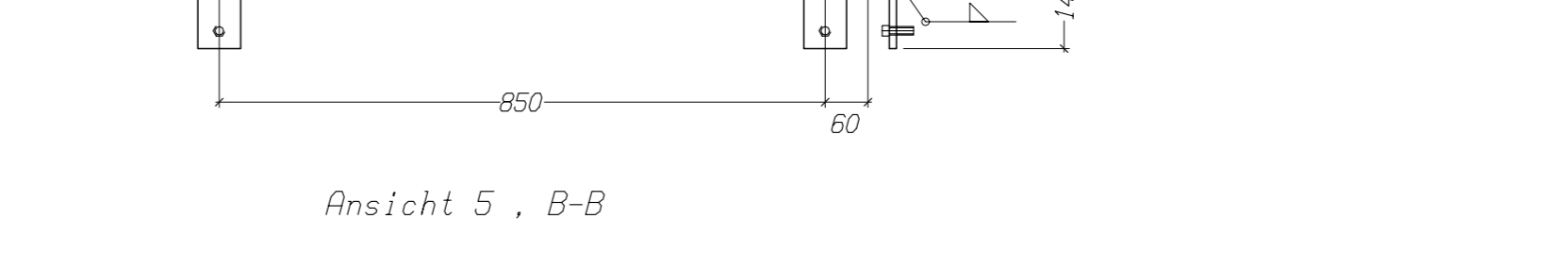
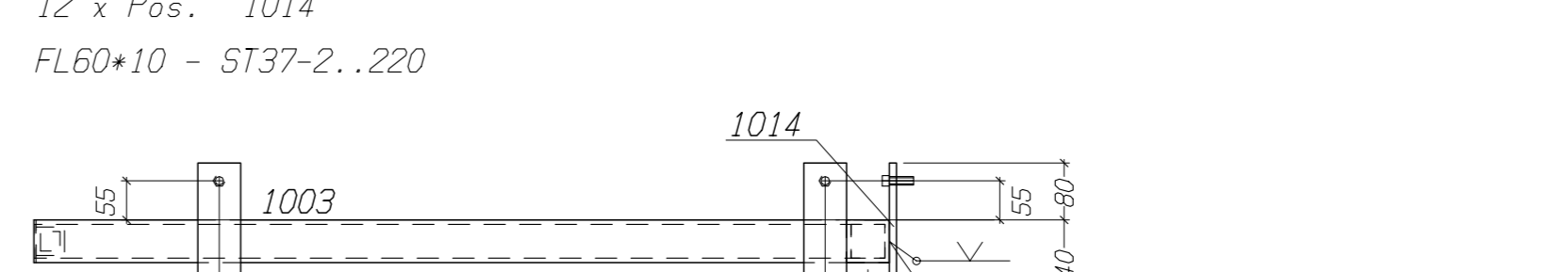
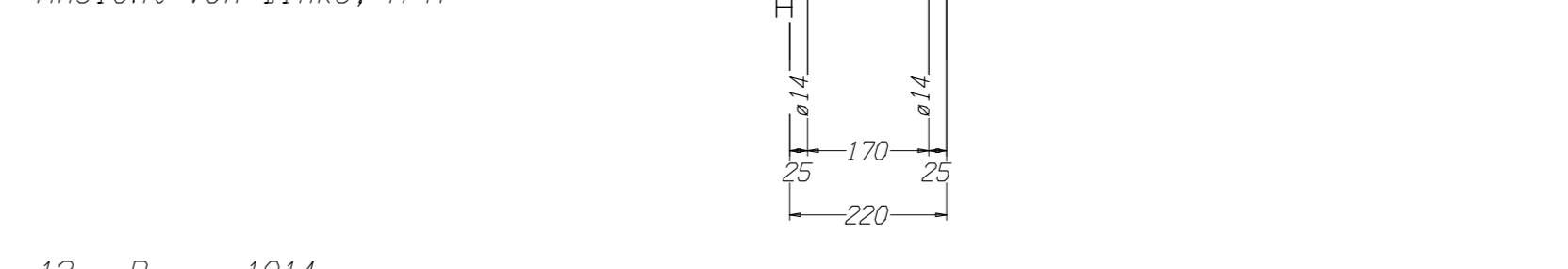
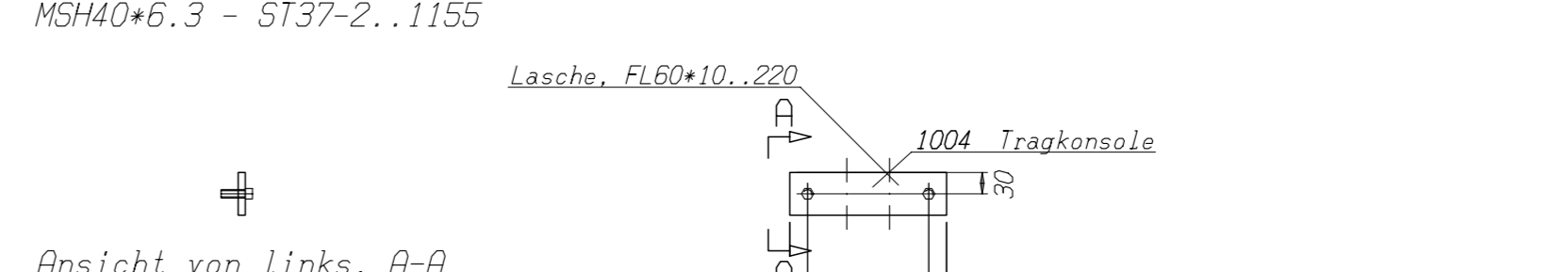
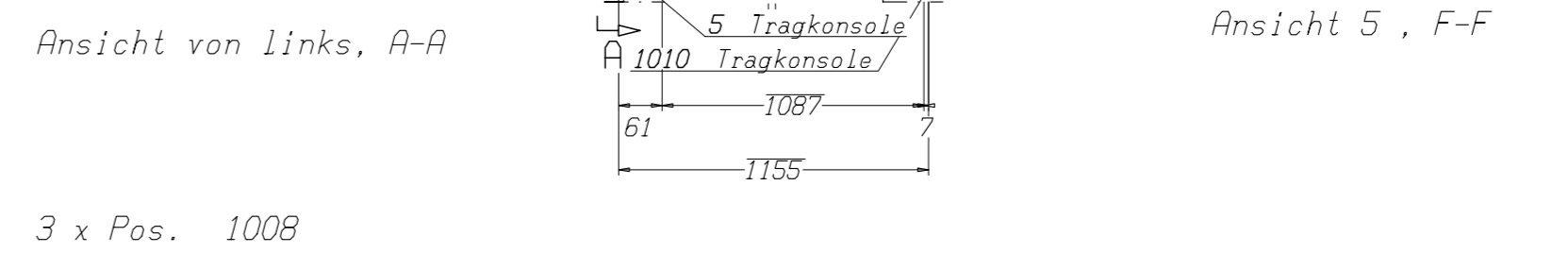
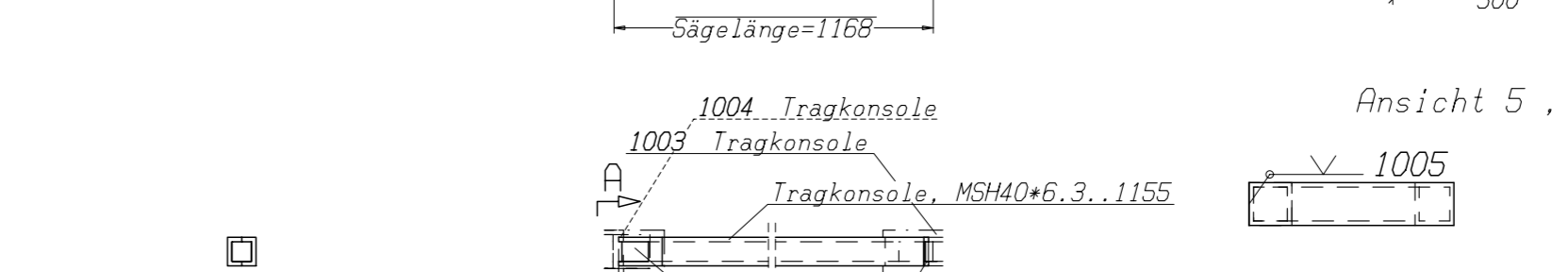
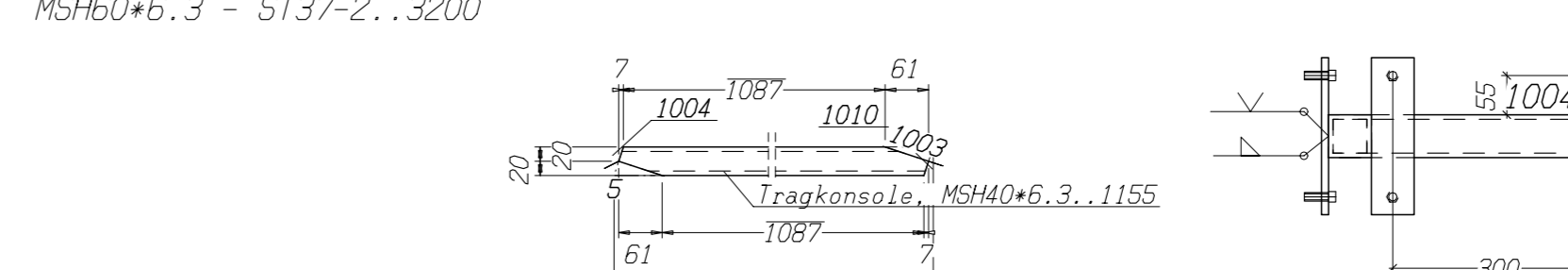
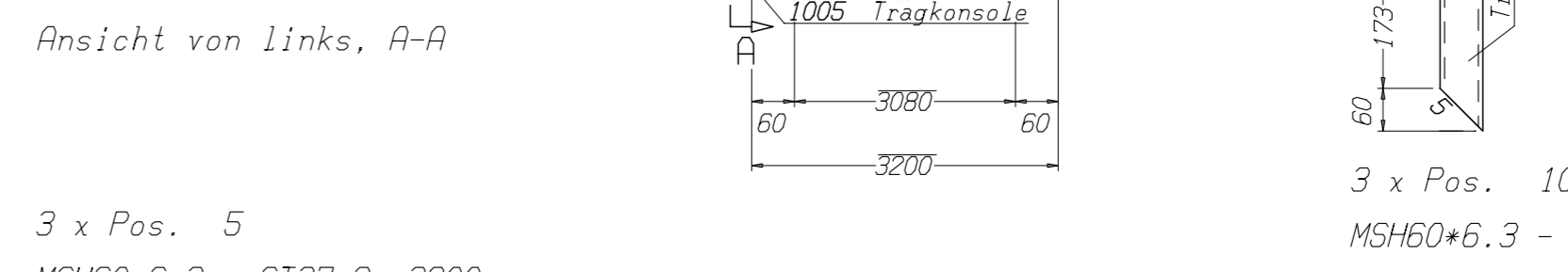
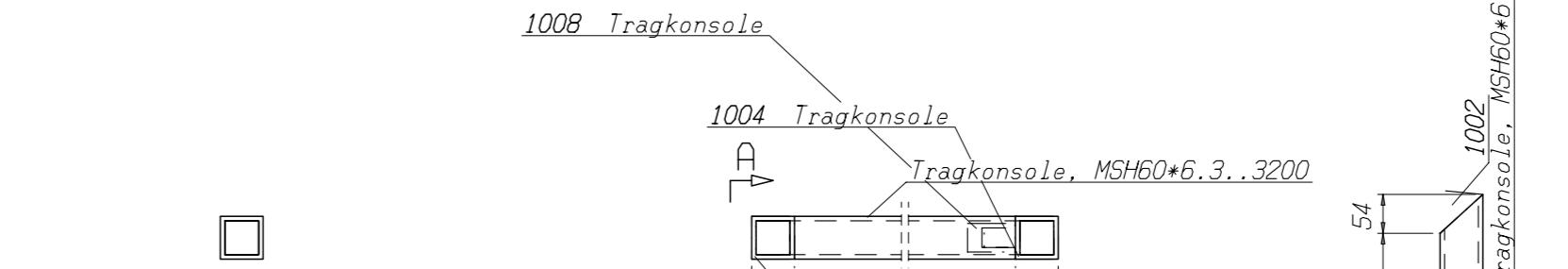
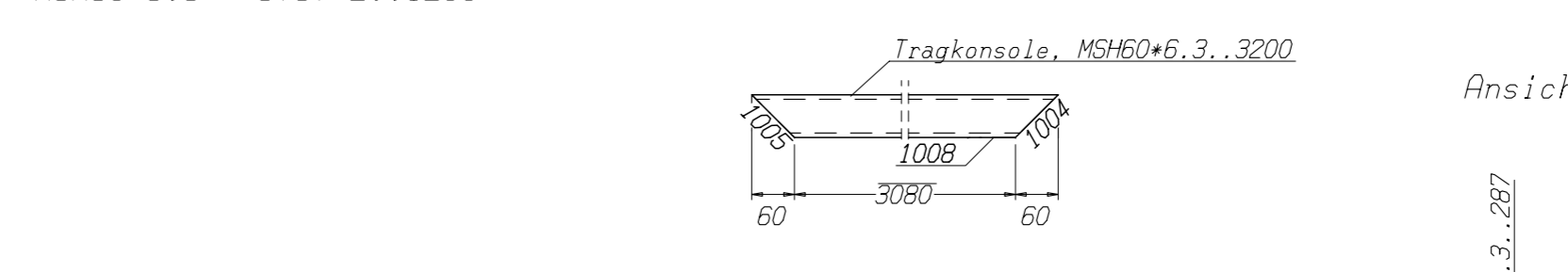
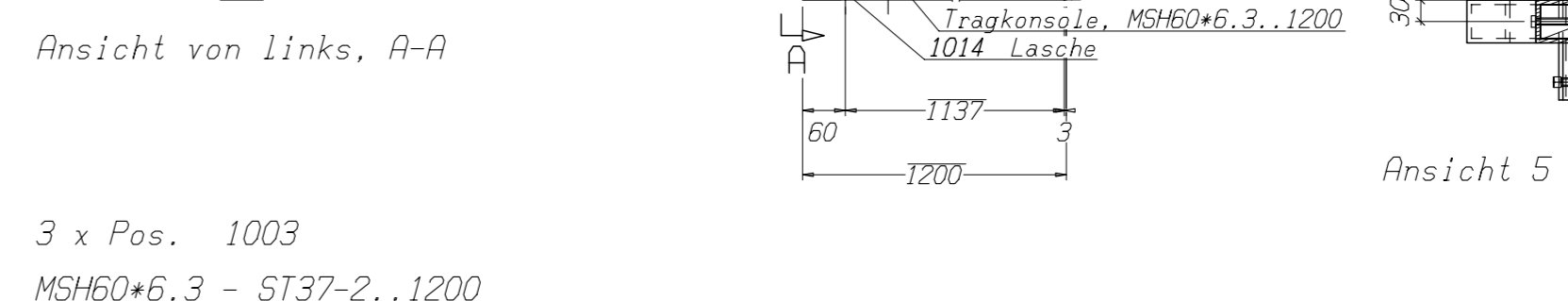
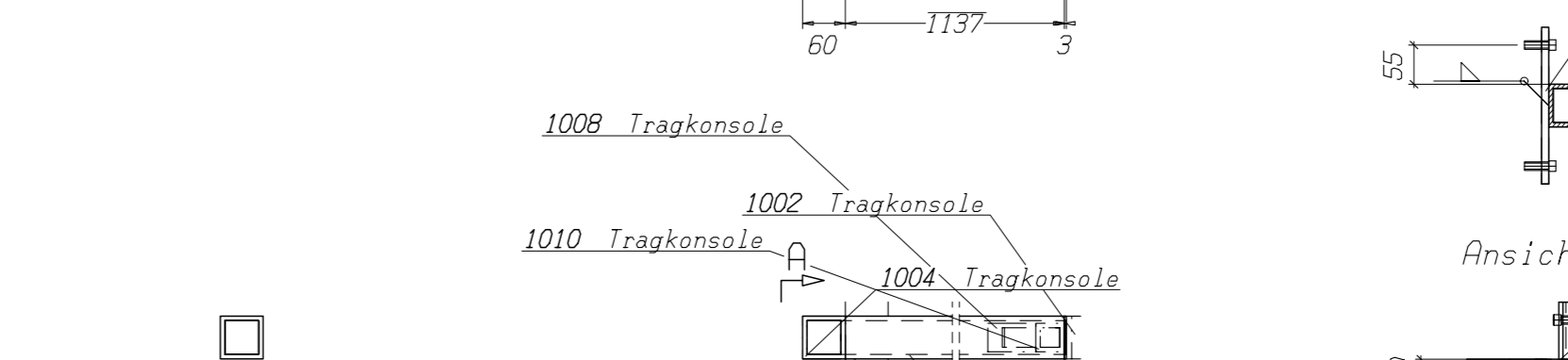
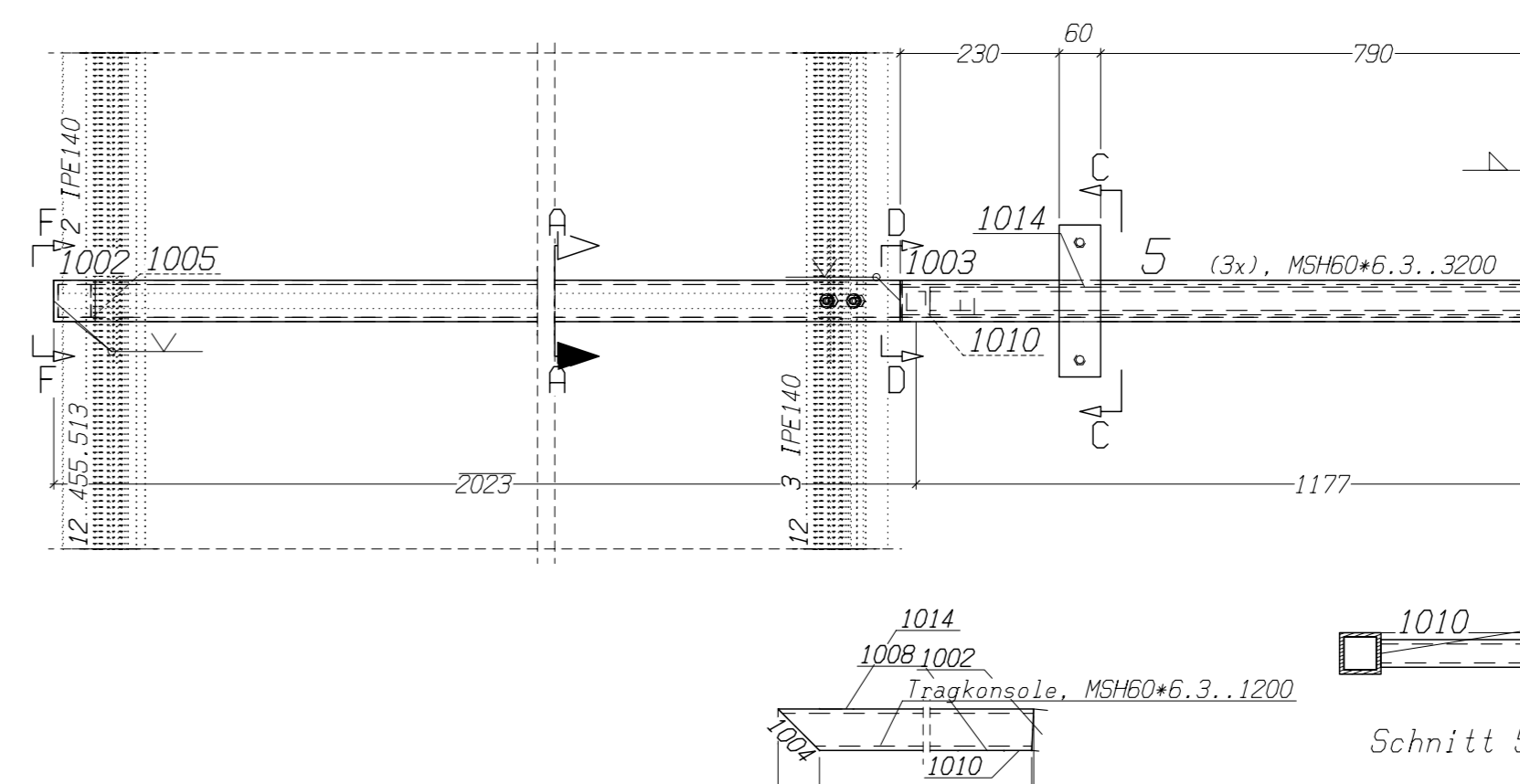

TS	Pos.	Stk.	Benennung	Profil	Material	Länge	Gewicht	Bem.
1	1	1	Längsträger vorne	IPE140	ST37-2	7670	98.94	

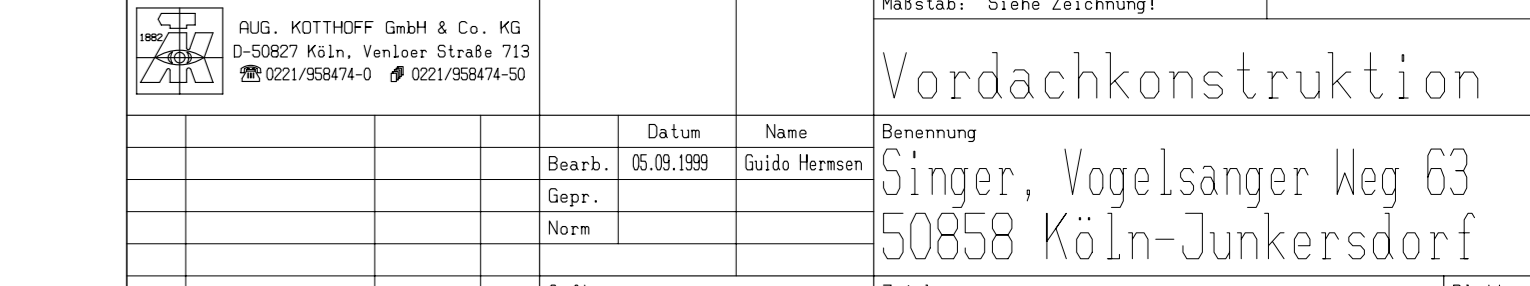
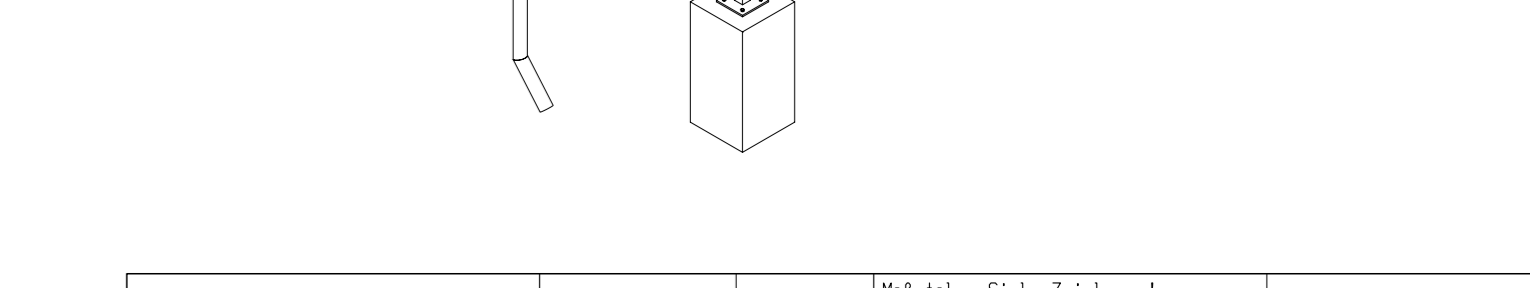
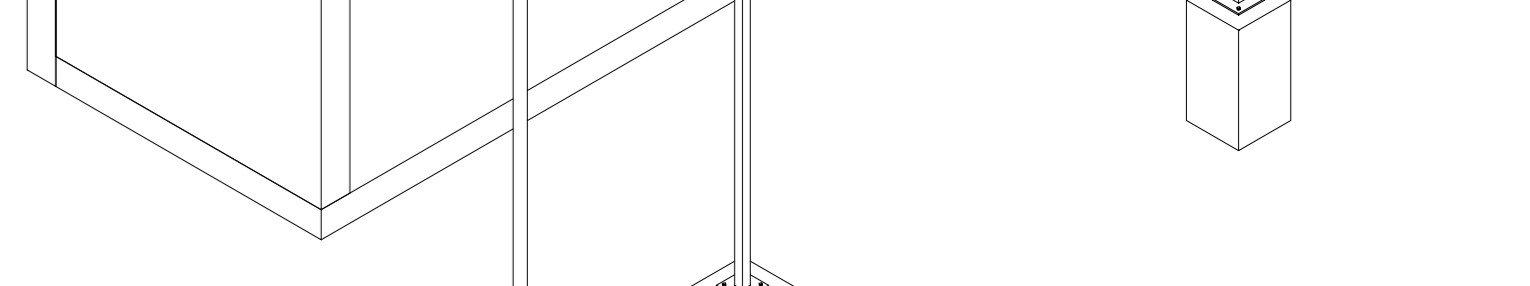
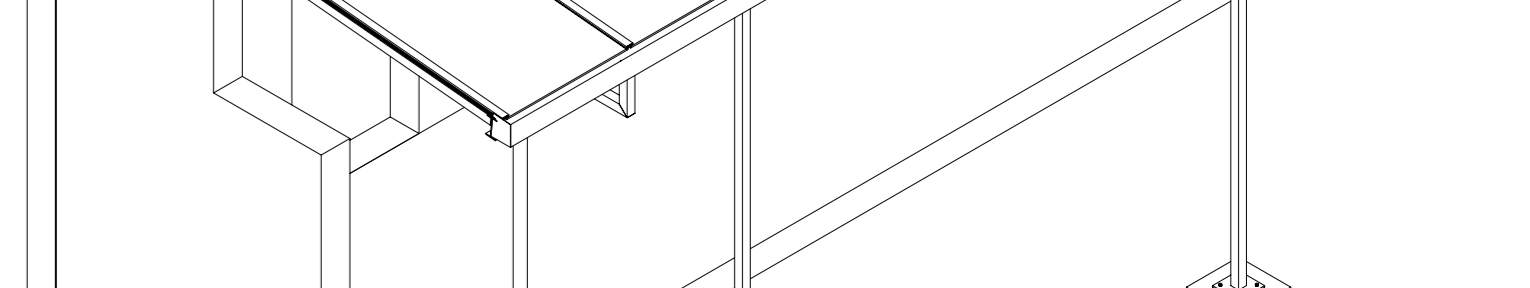
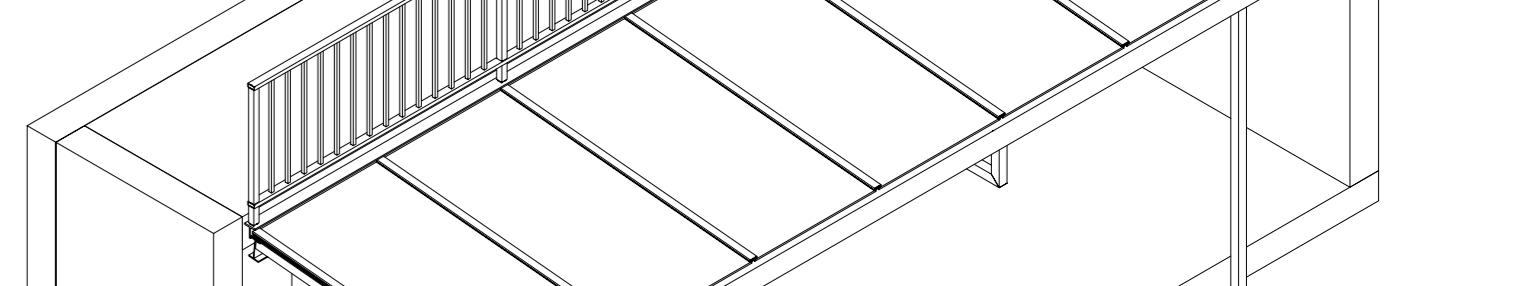
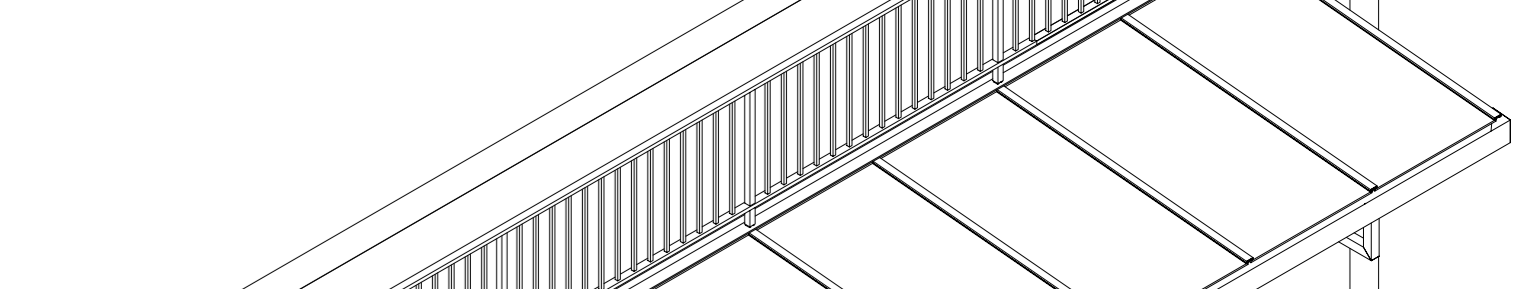
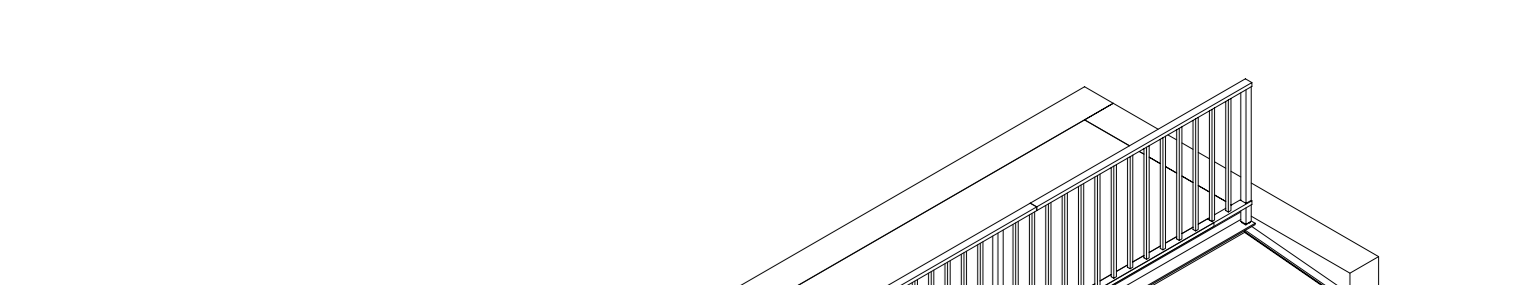
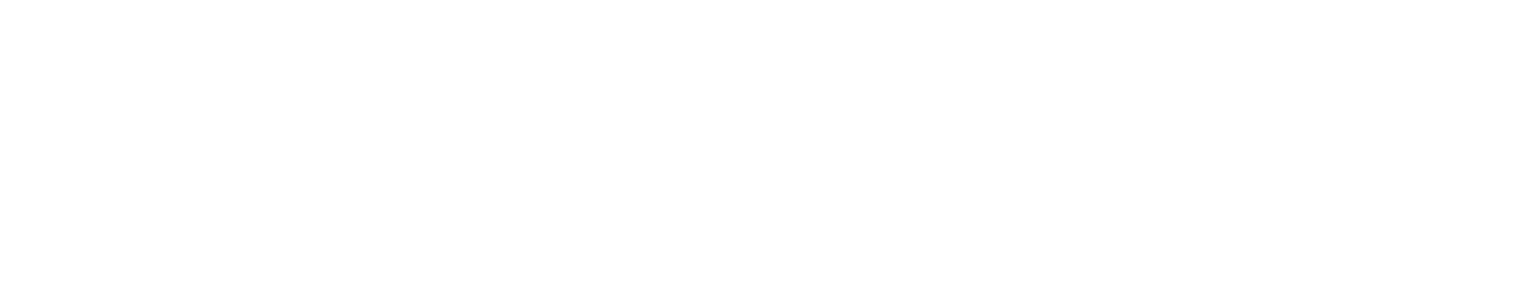
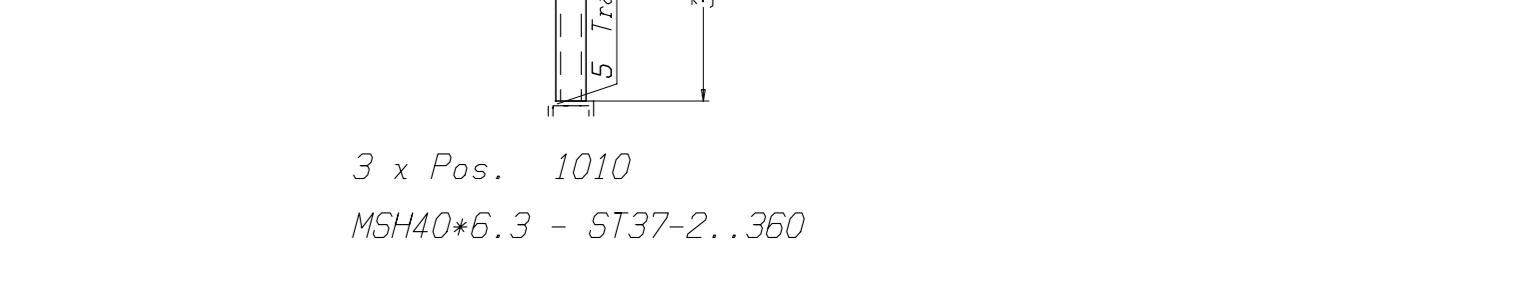
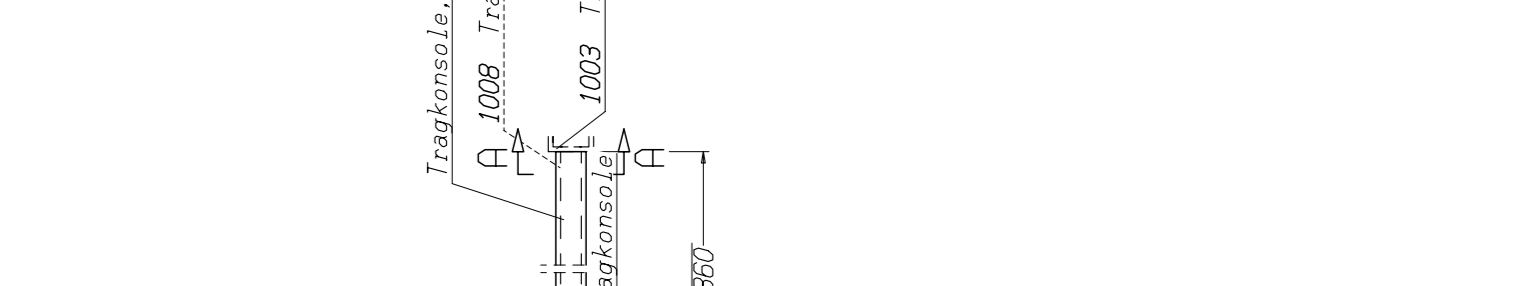
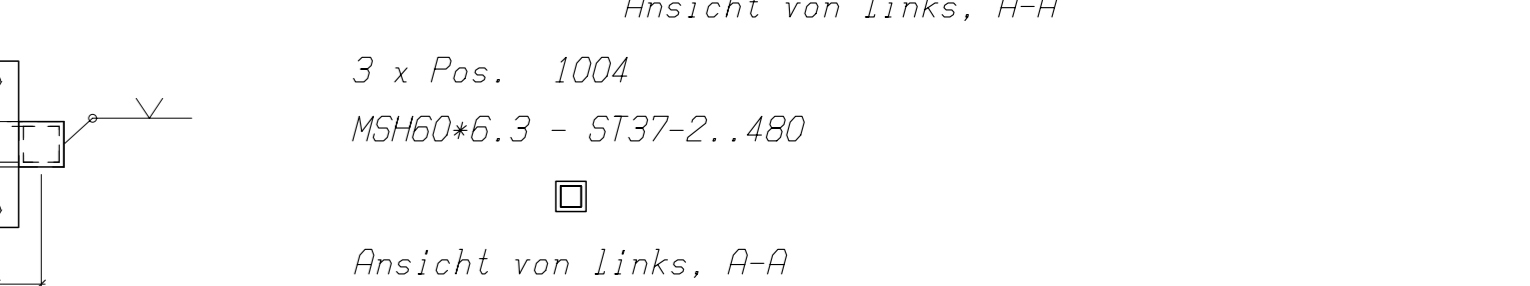
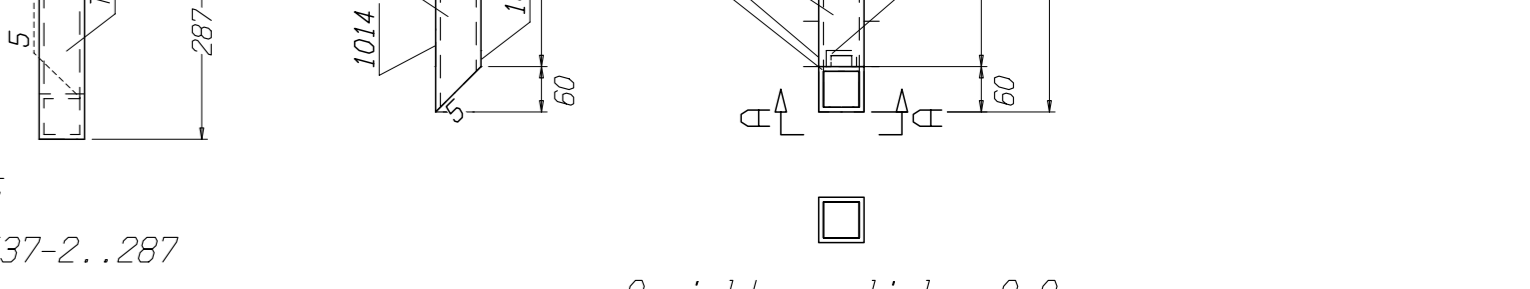
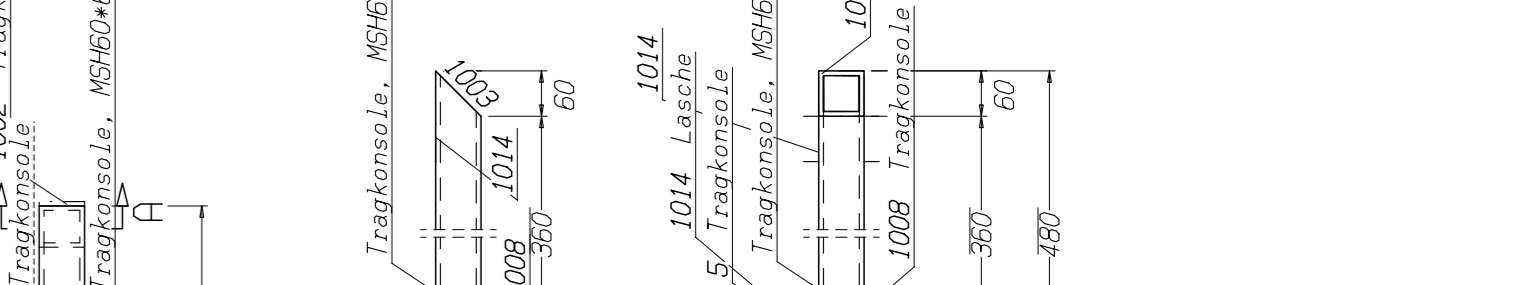
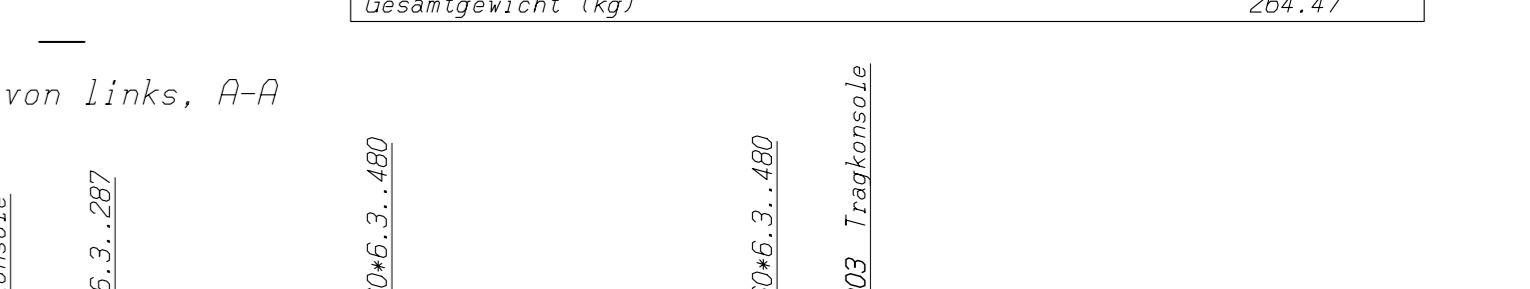
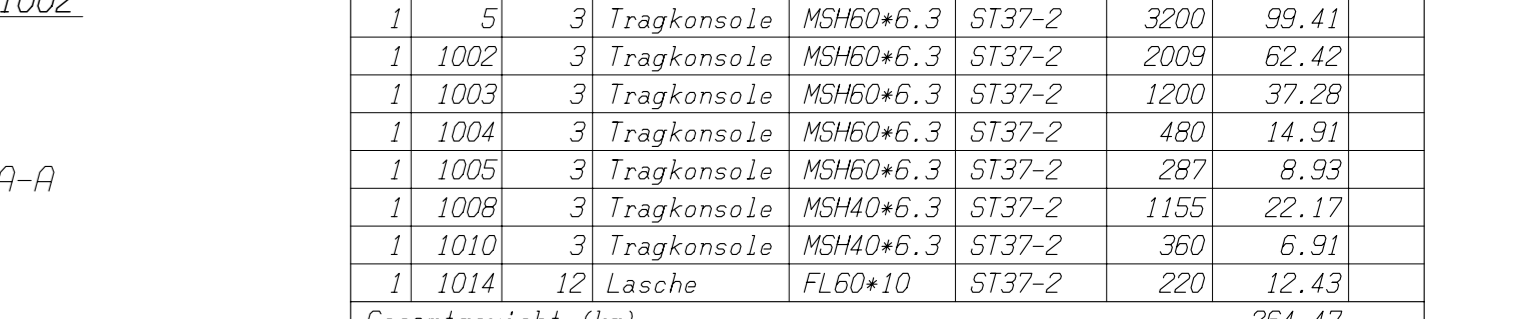
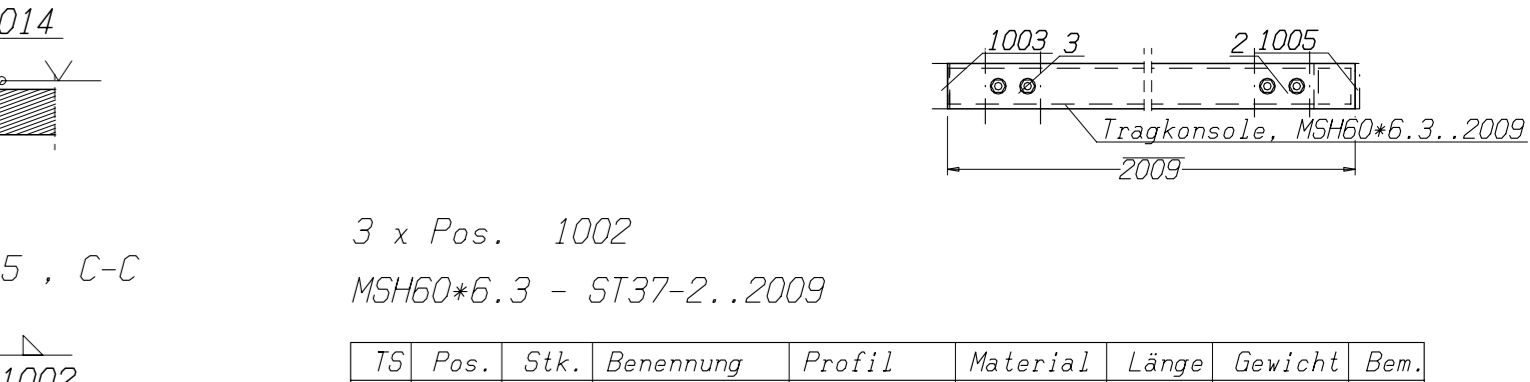
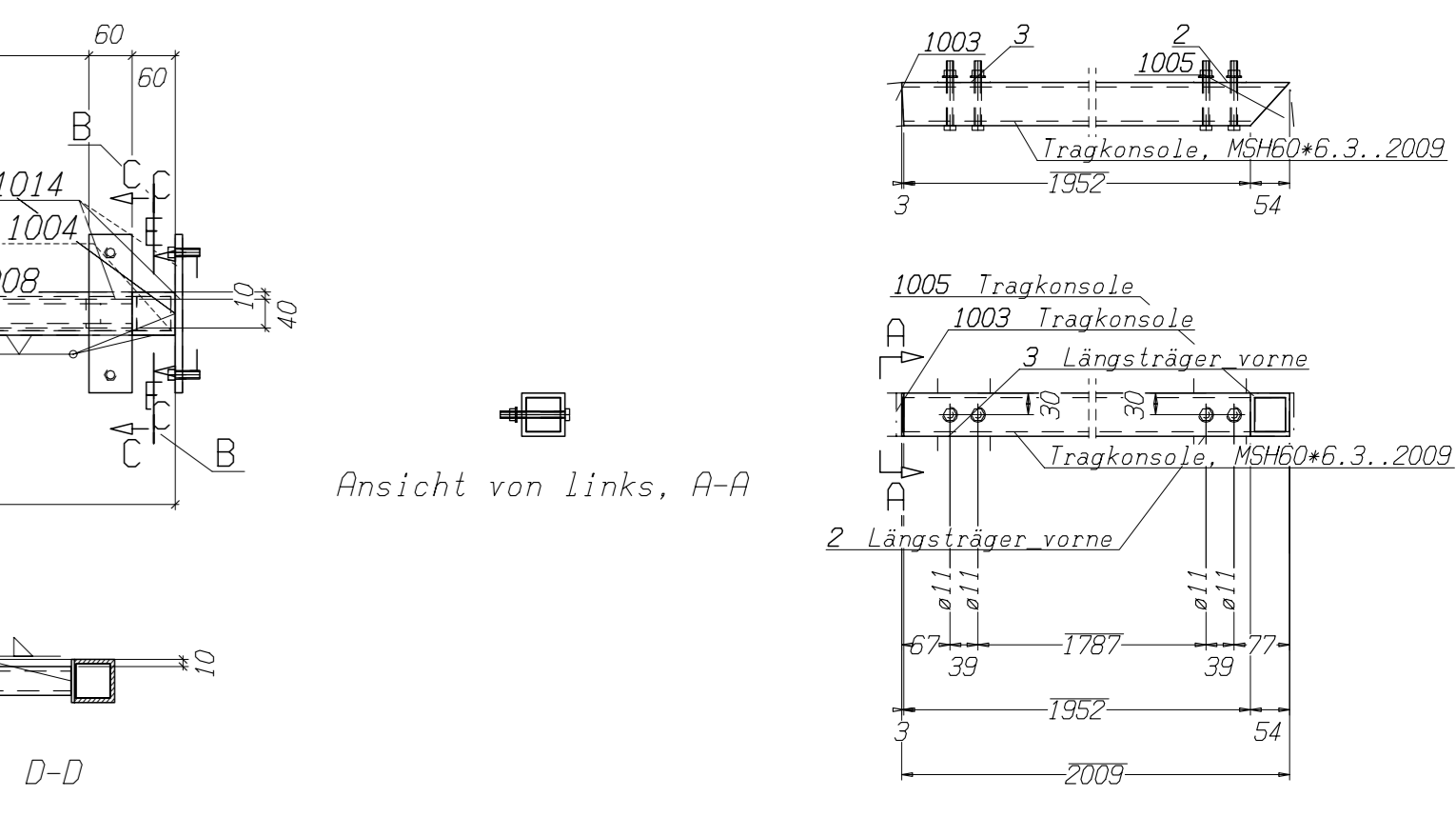

TS	Pos.	Stk.	Benennung	Profil	Material	Länge	Gewicht	Bem.
1	1	1	Längsträger vorne	IPE140	ST37-2	7670	98.94	

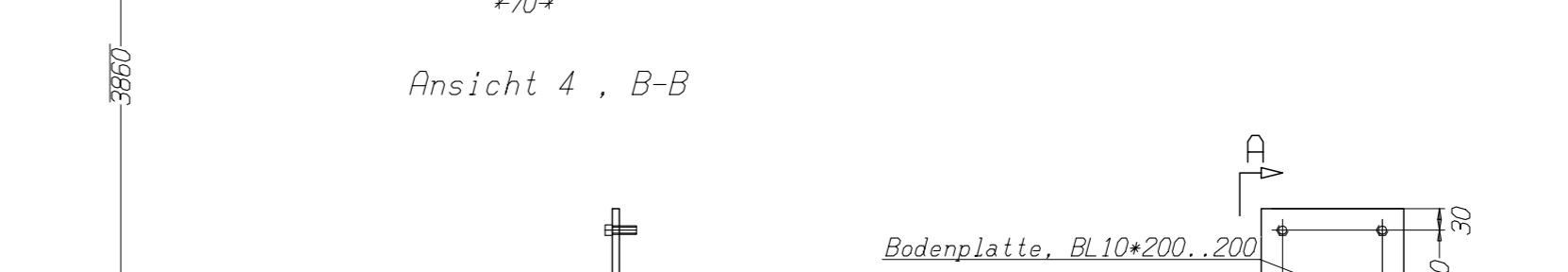
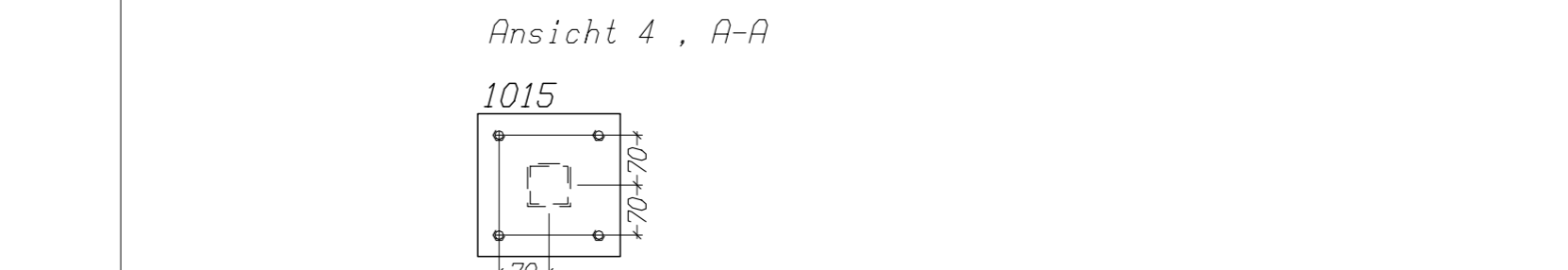
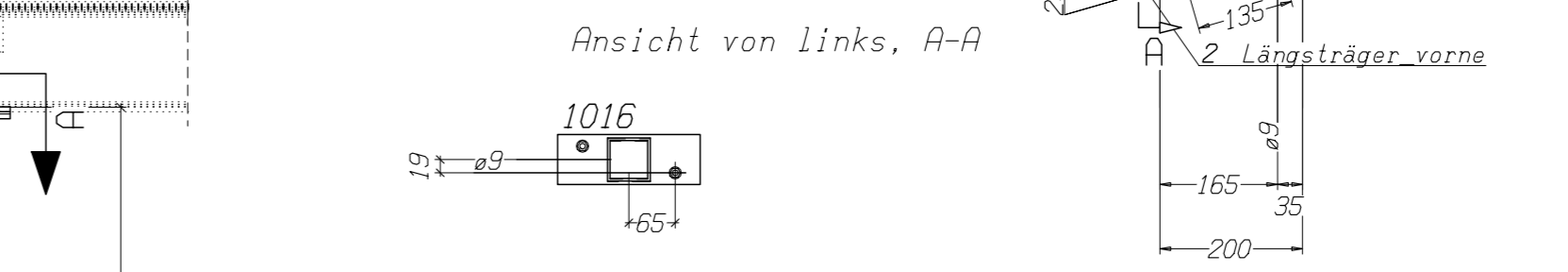
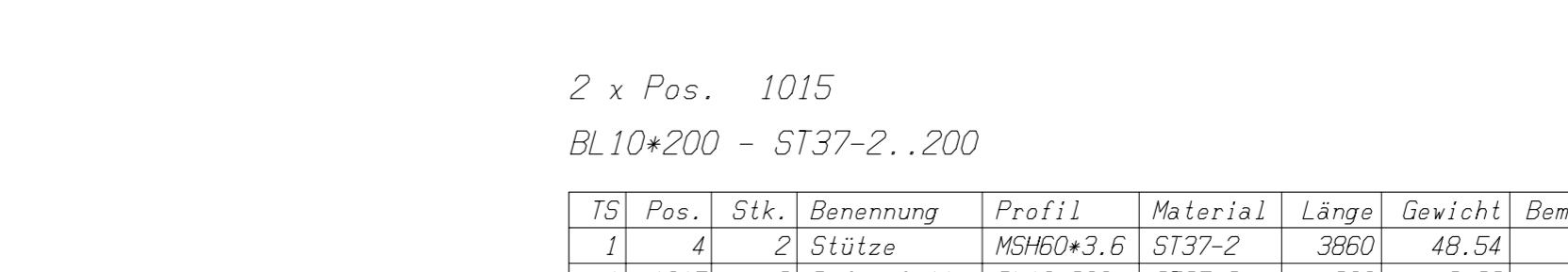
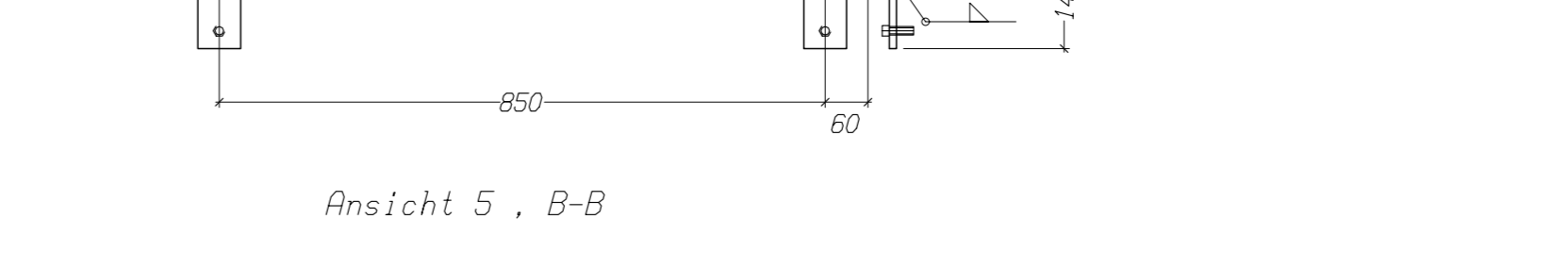
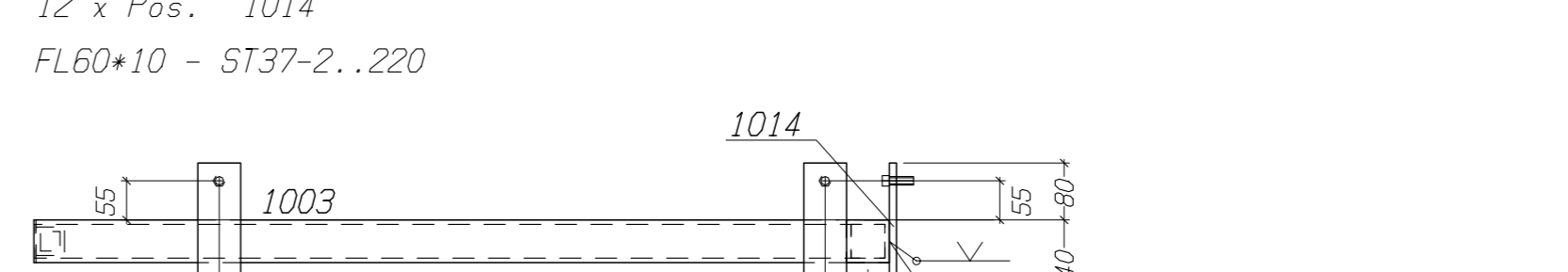
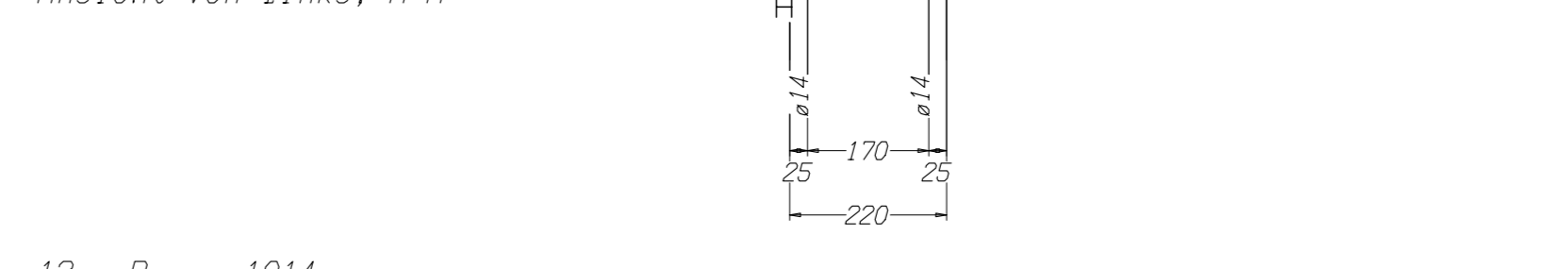
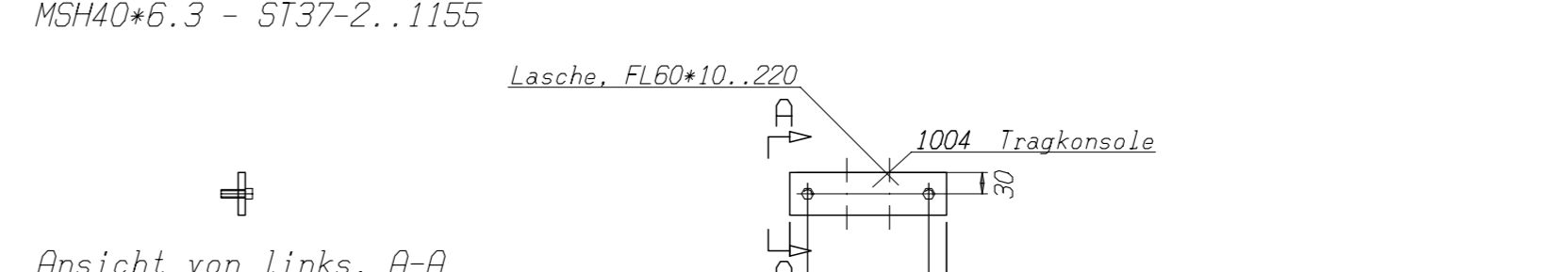
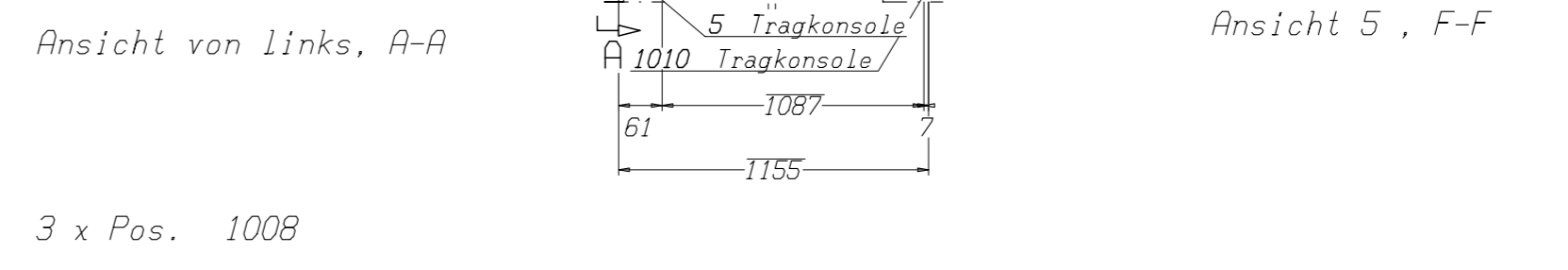
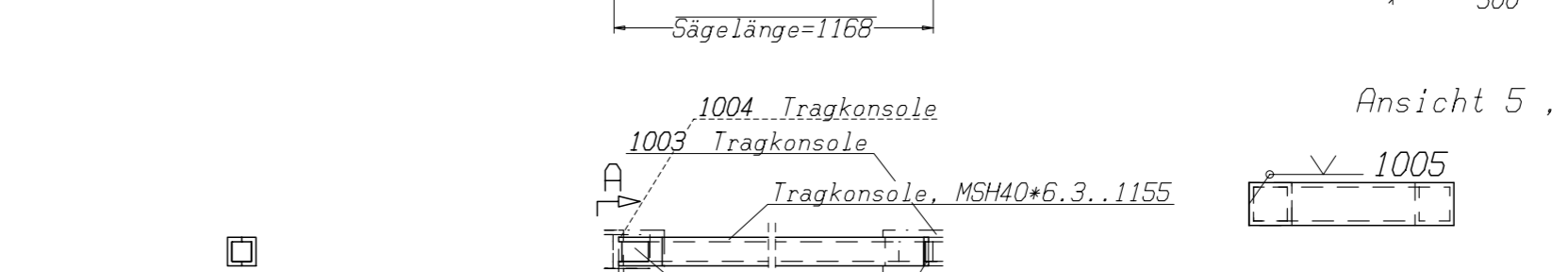
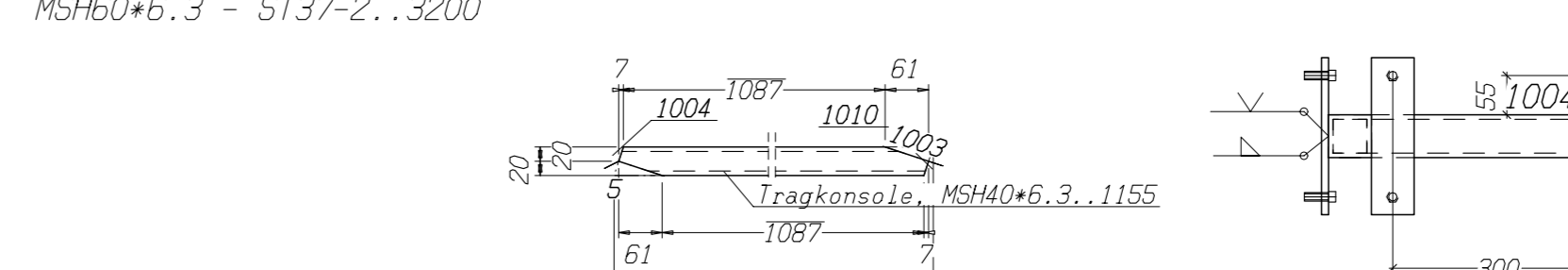
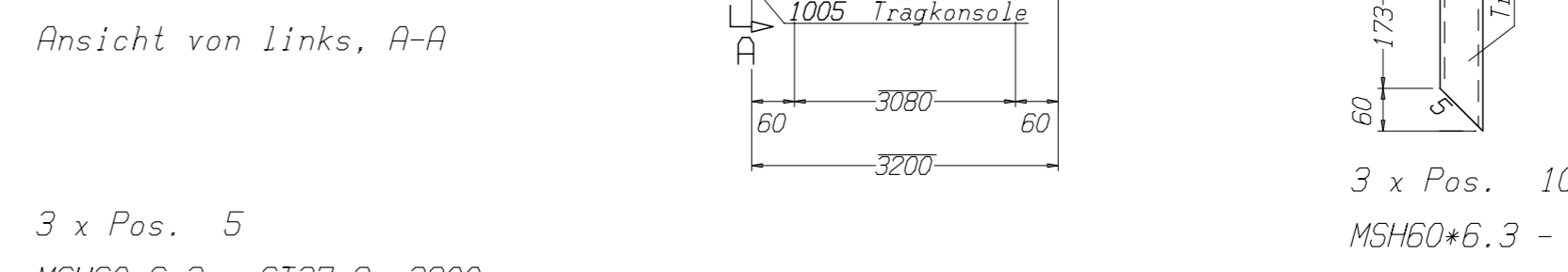
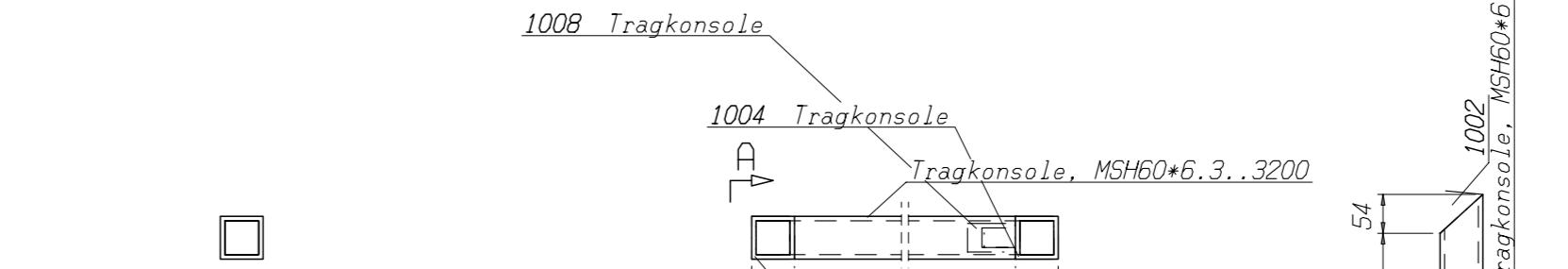
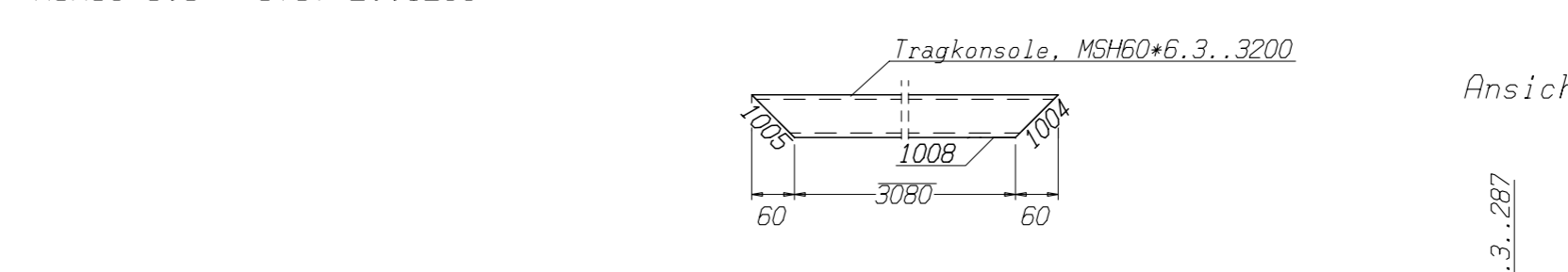
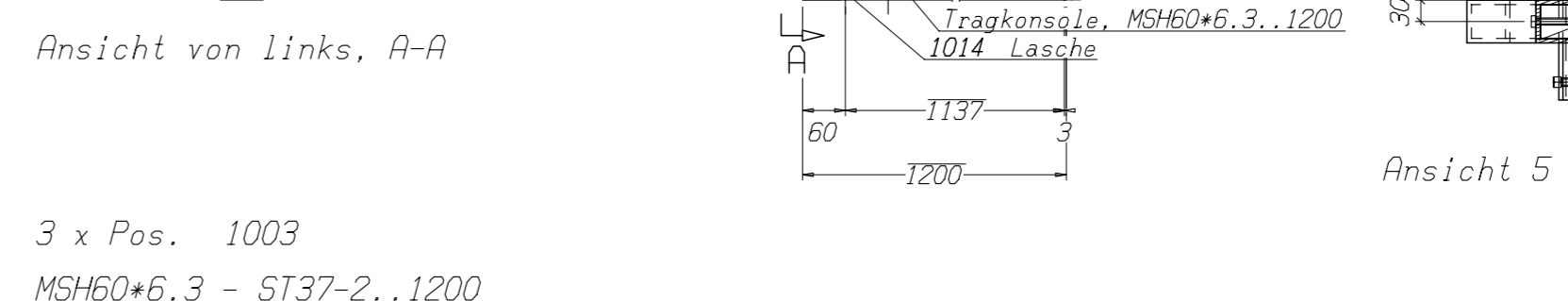
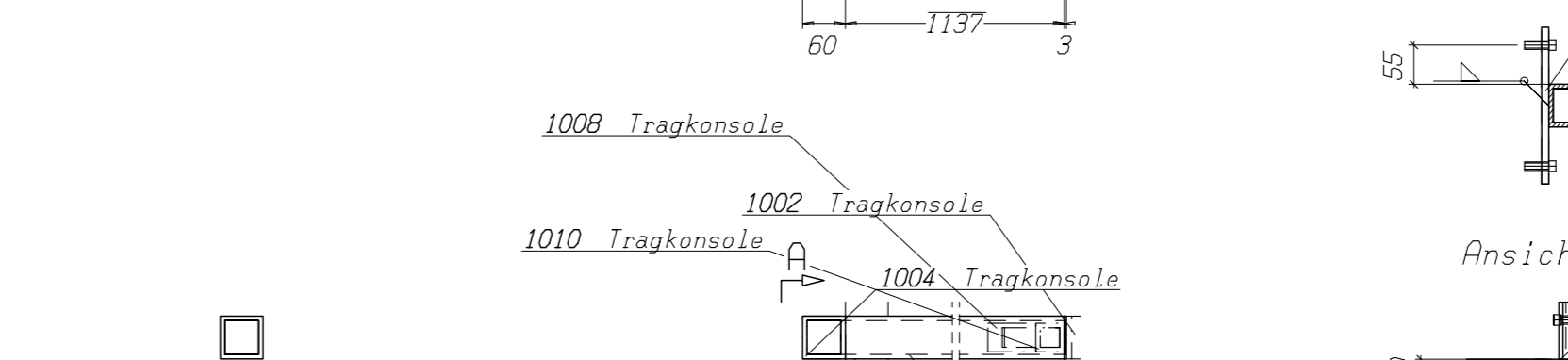

TS	Pos.	Stk.	Benennung	Profil	Material	Länge	Gewicht	Bem.
1	1	1	Längsträger vorne	IPE140	ST37-2	7670	98.94	

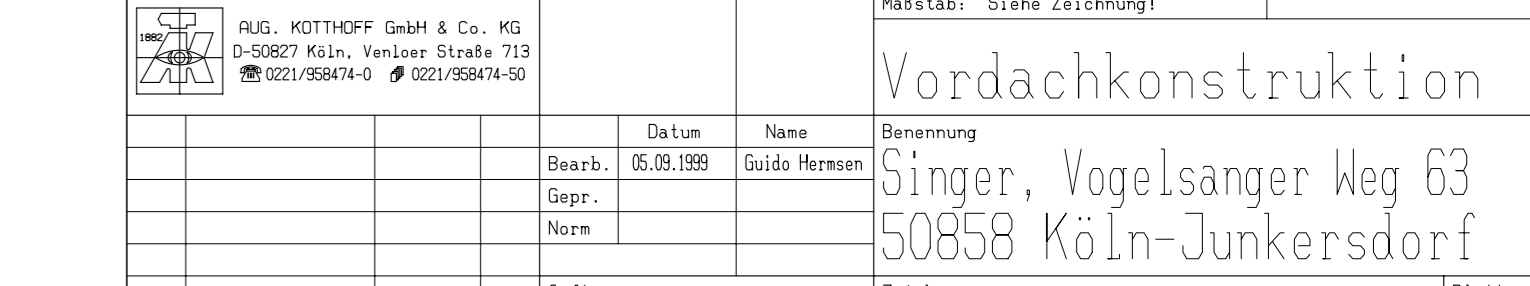
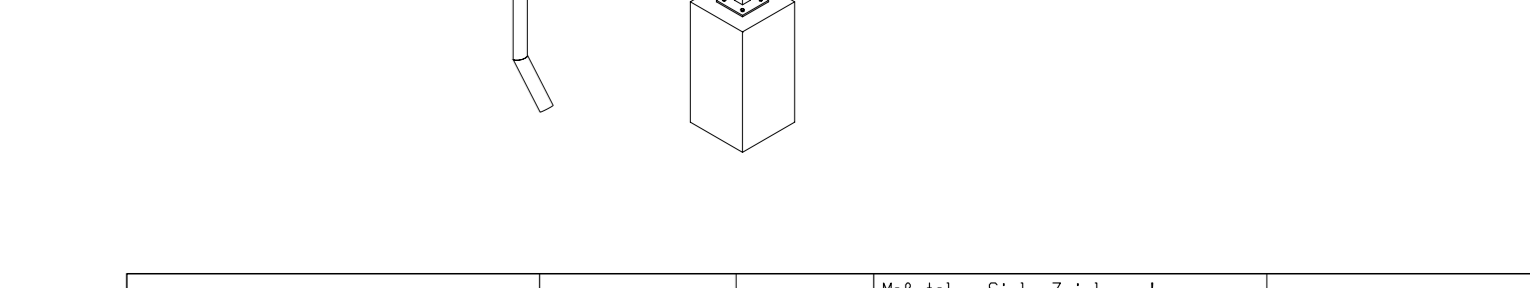
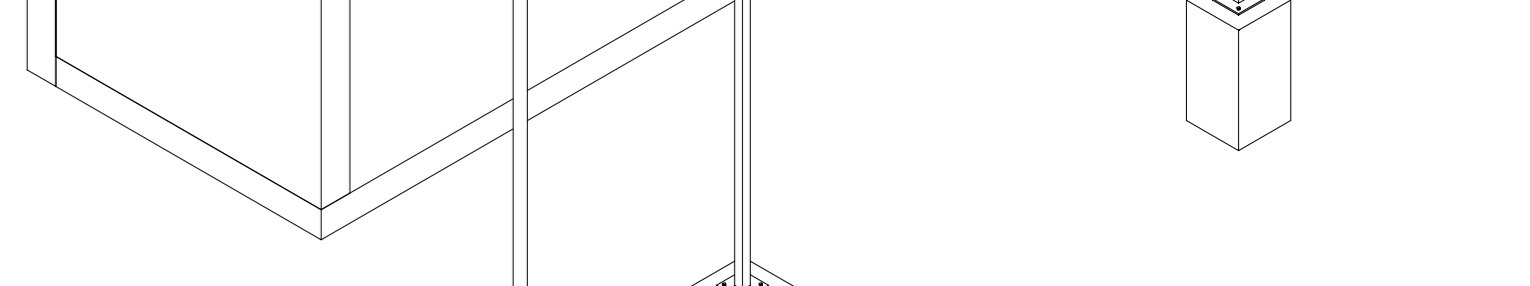
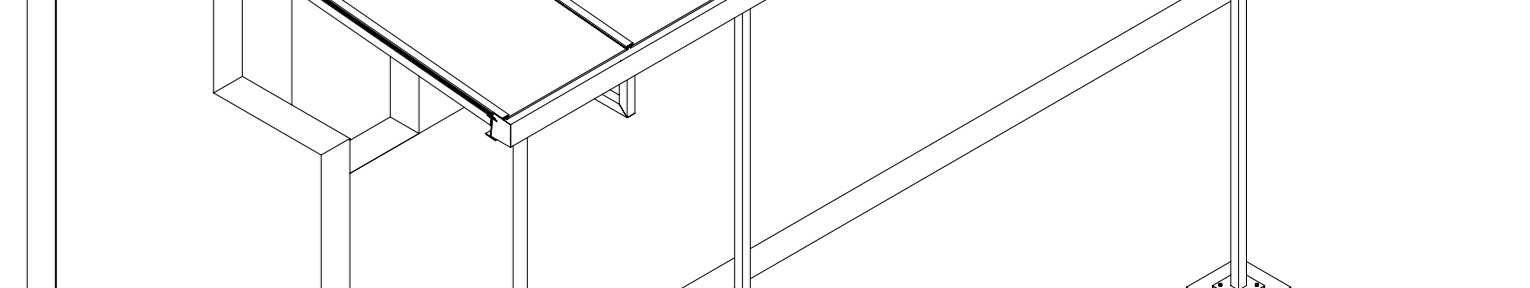
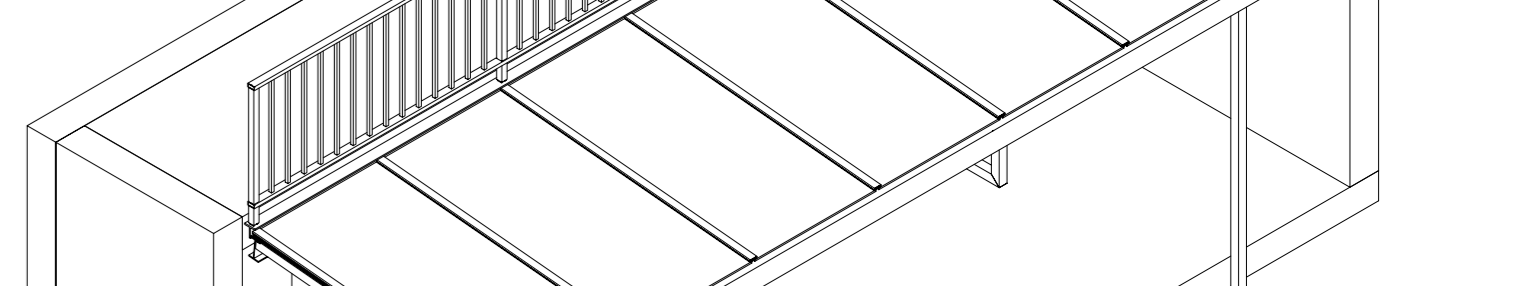
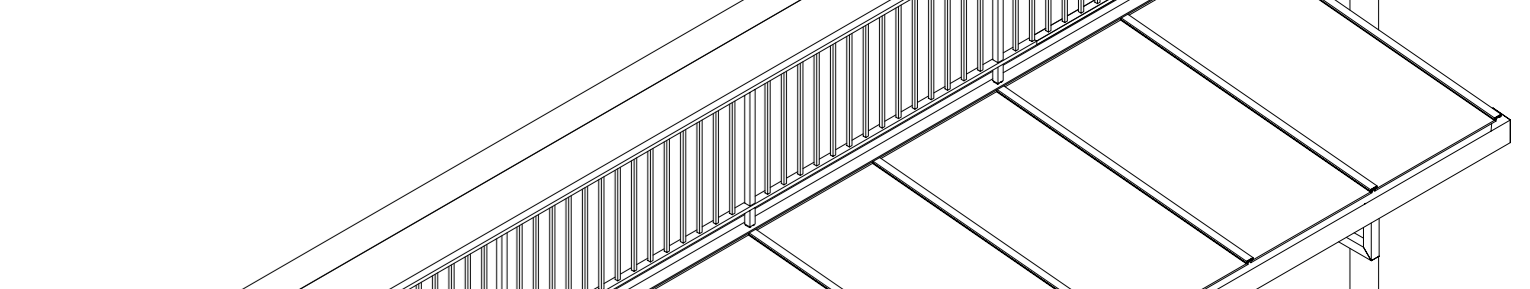
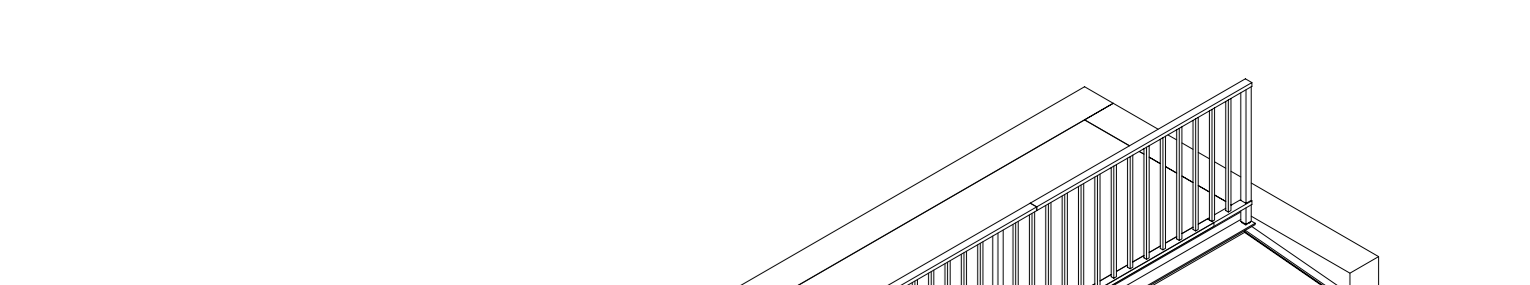
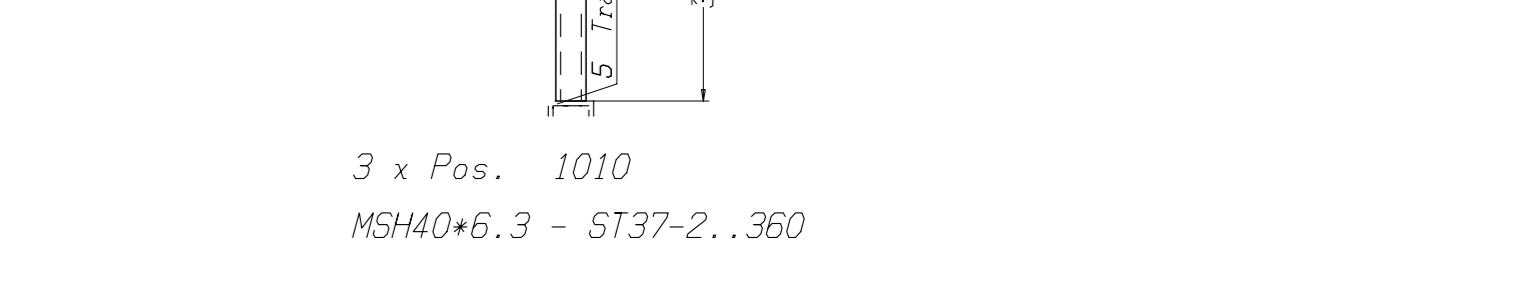
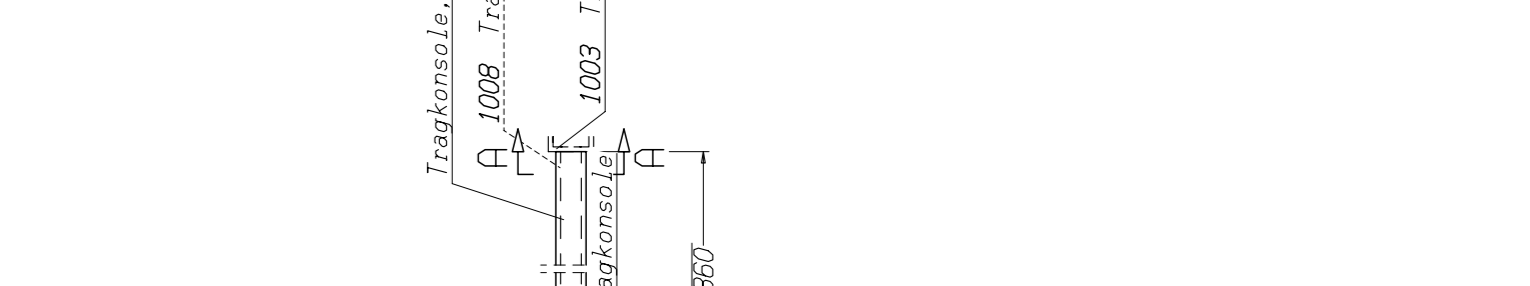
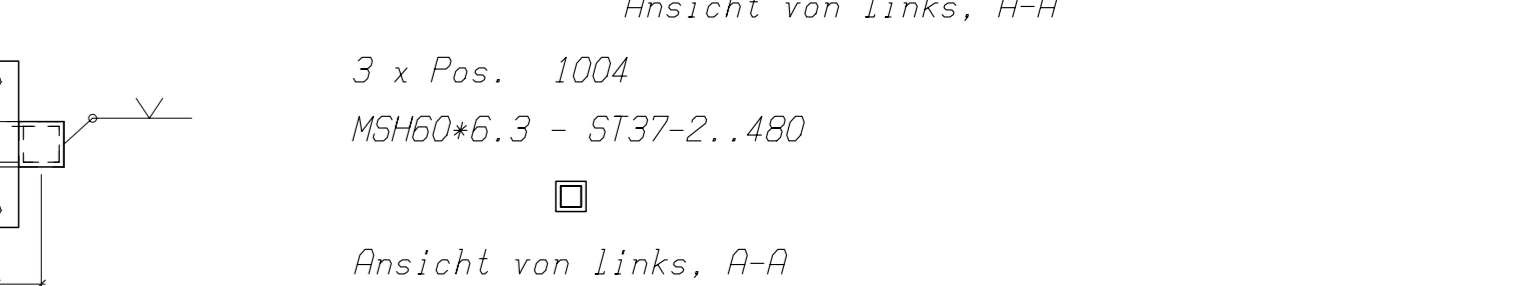
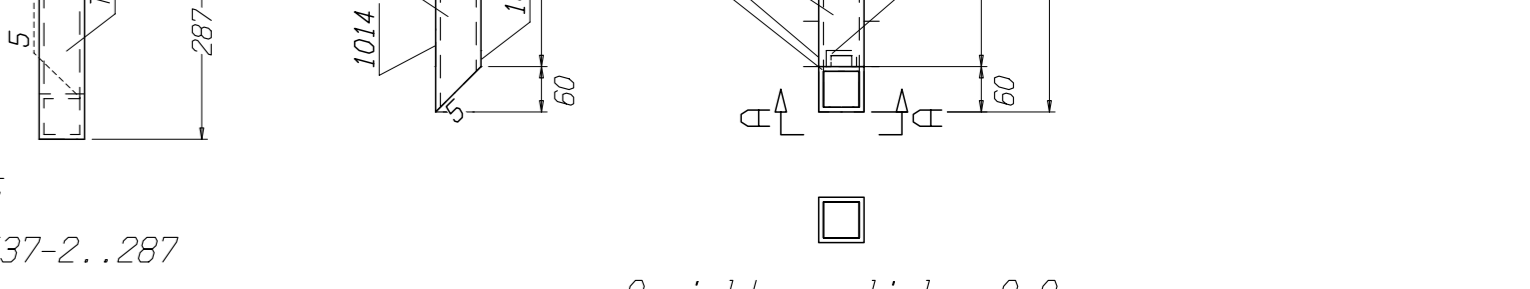
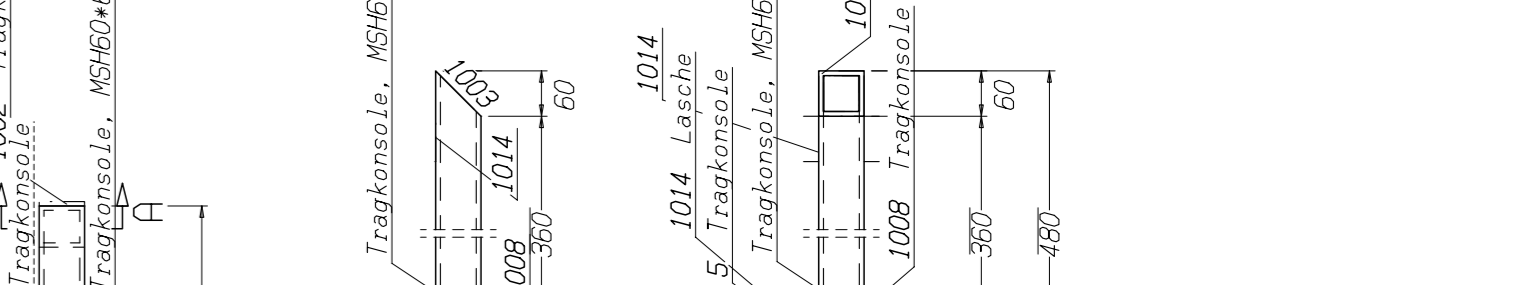
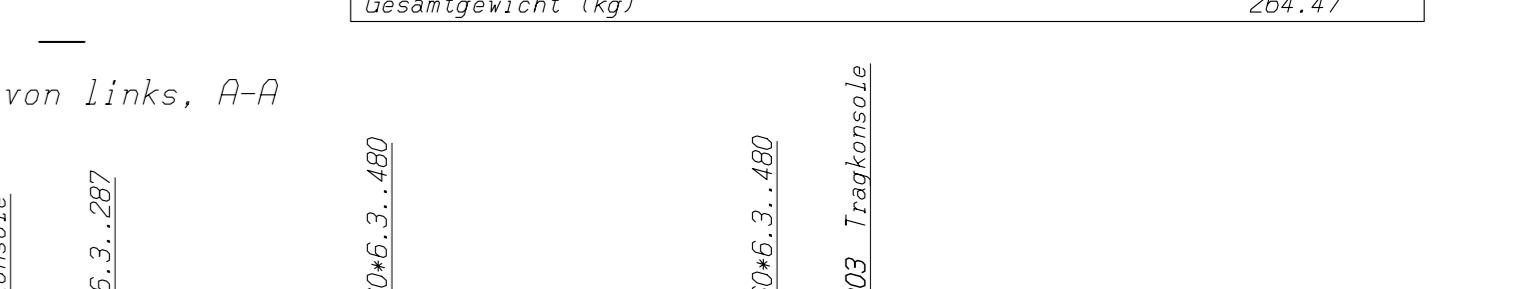
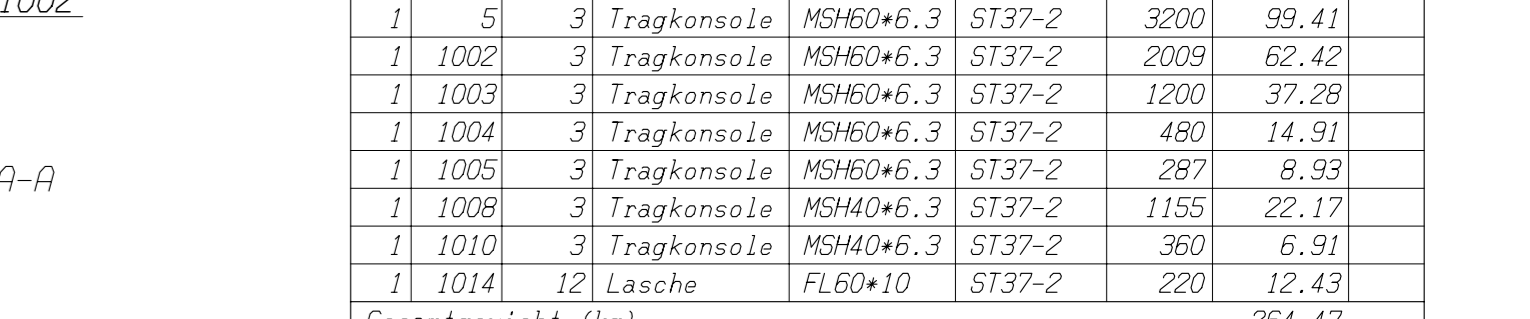
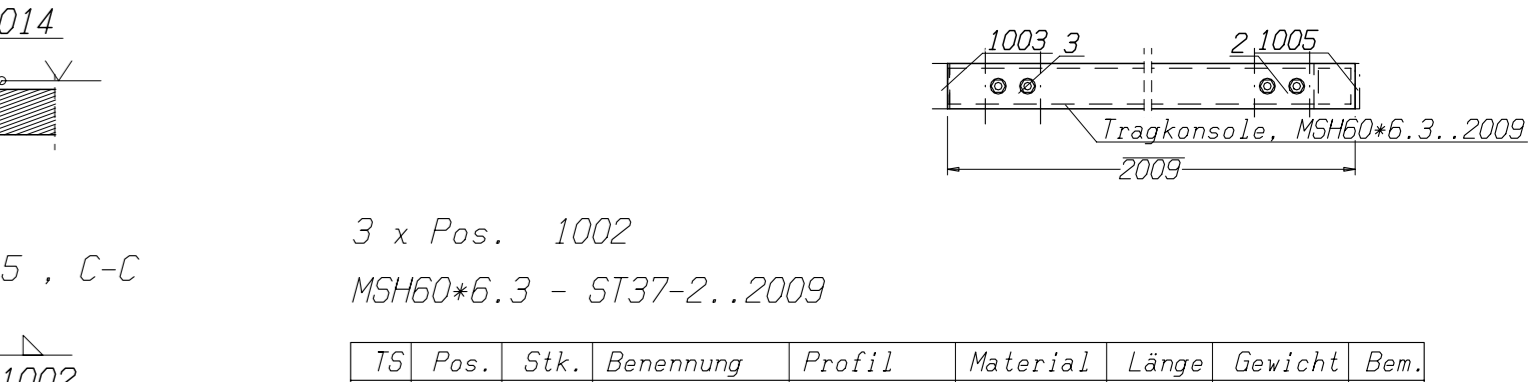

TS	Pos.	Stk.	Benennung	Profil	Material	Länge	Gewicht	Bem.
1	1	1	Längsträger vorne	IPE140	ST37-2	7670	98.94	

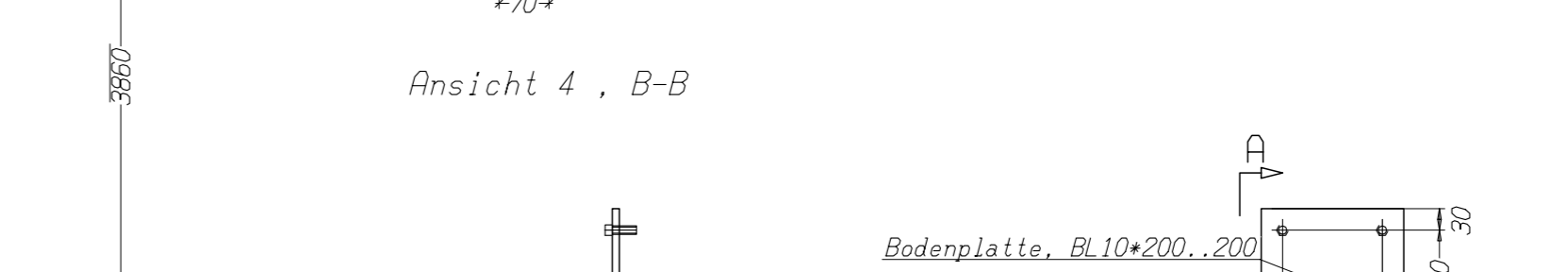
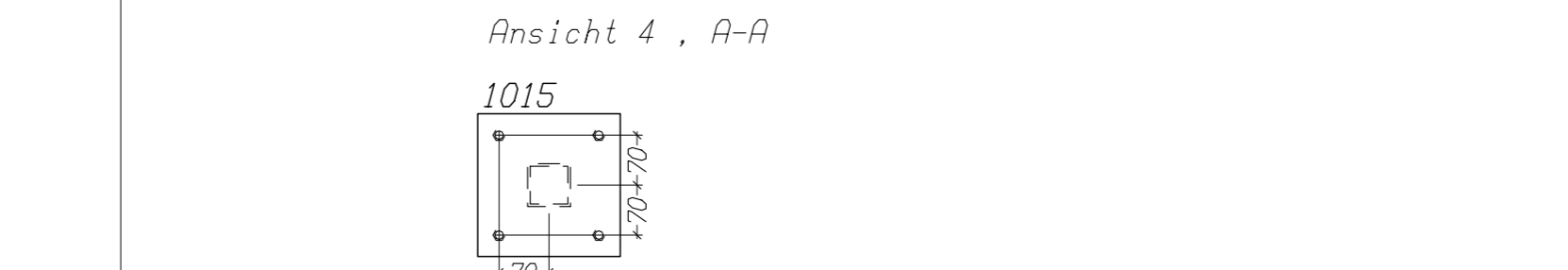
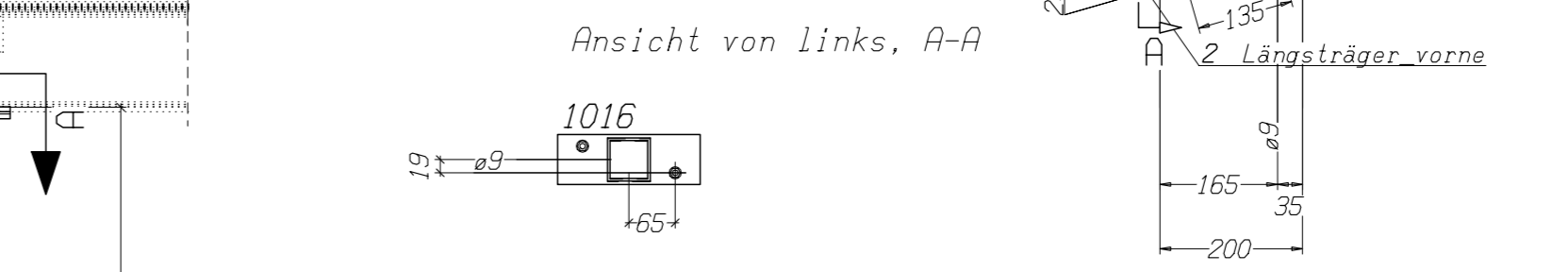
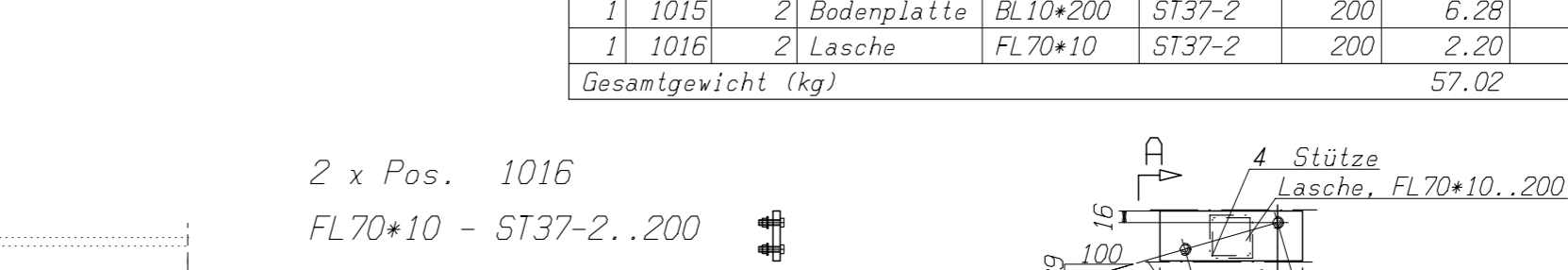
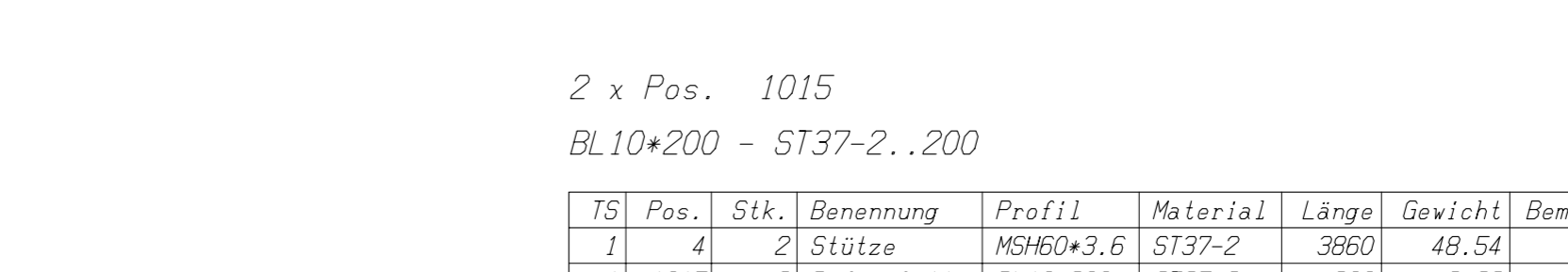
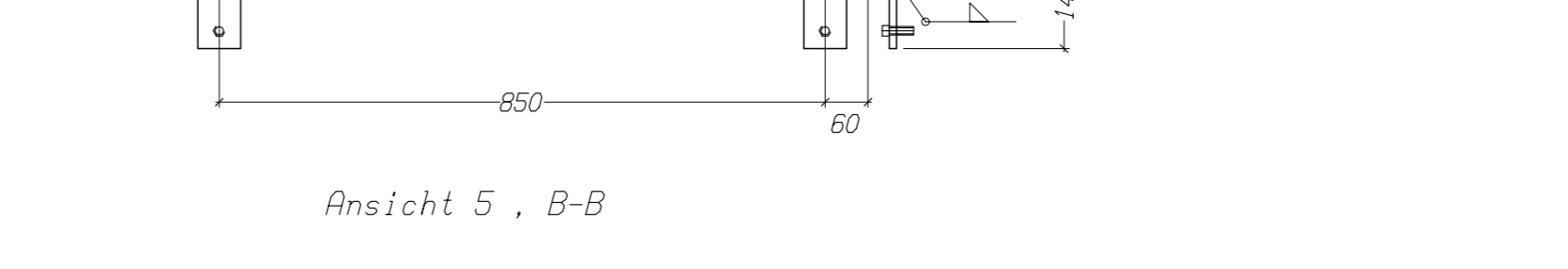
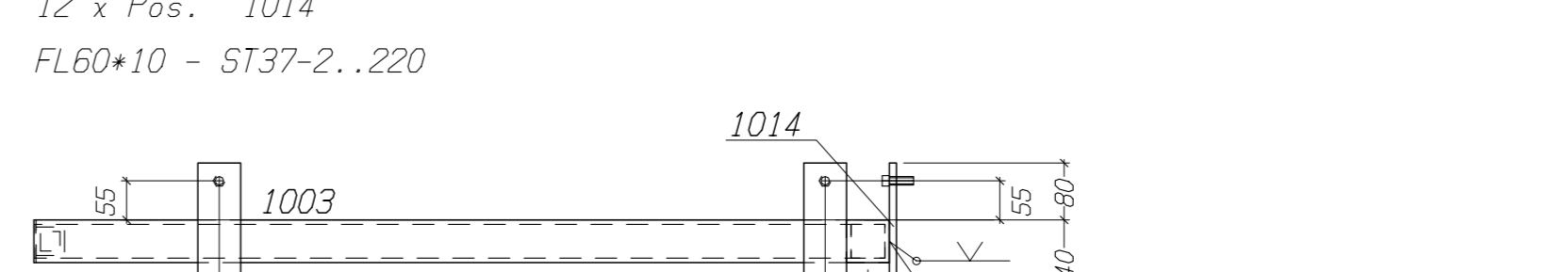
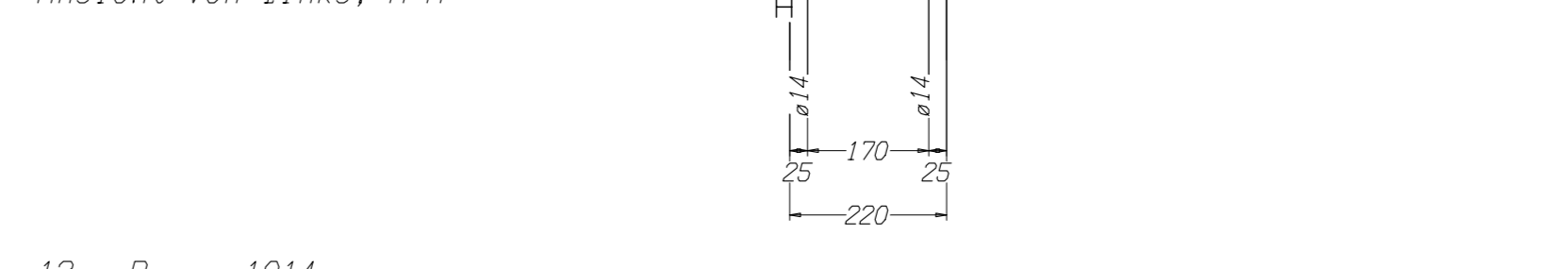
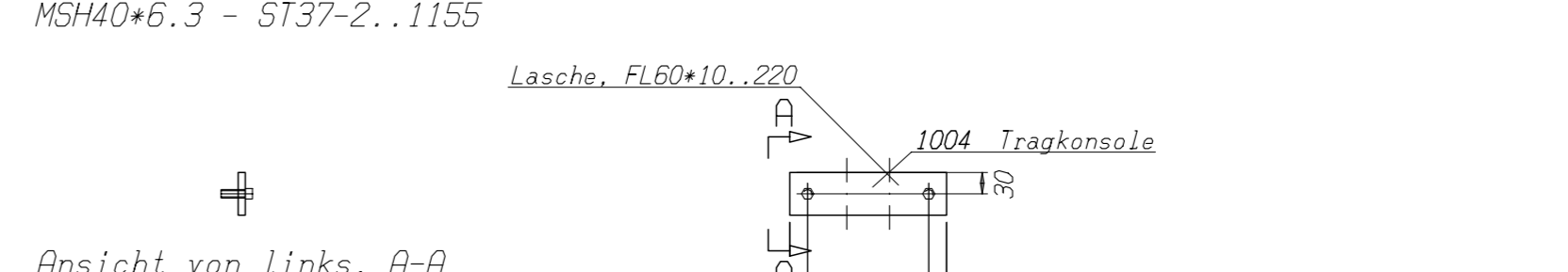
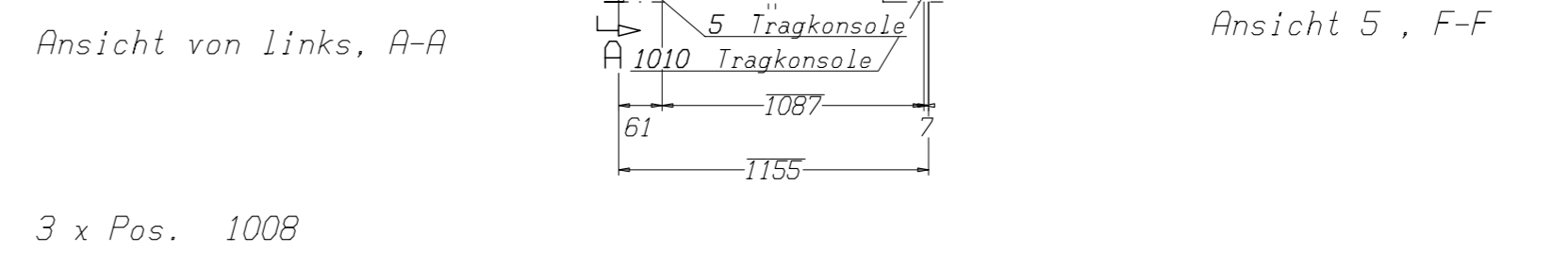
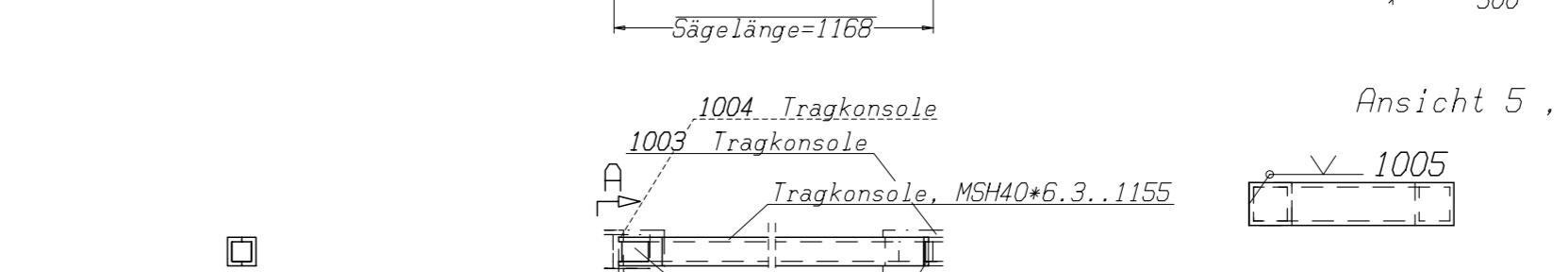
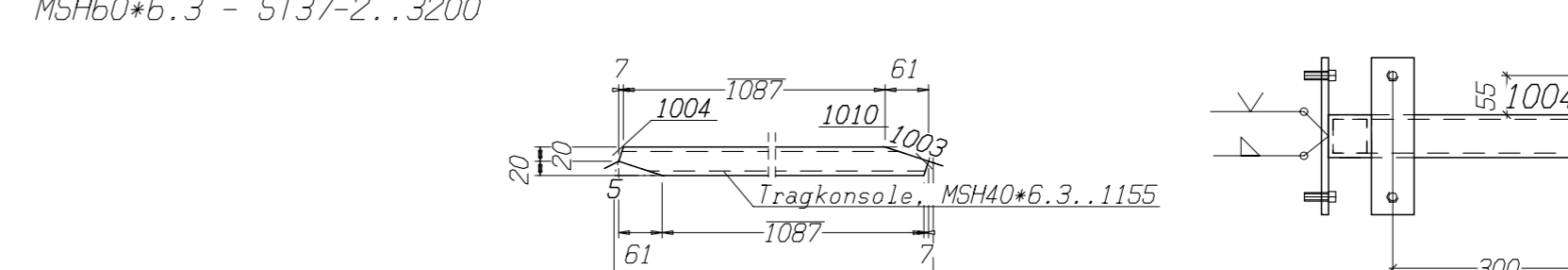
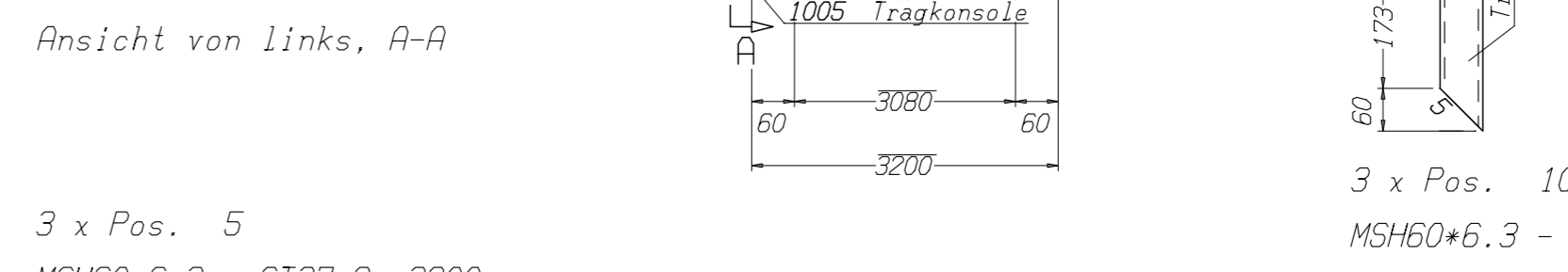
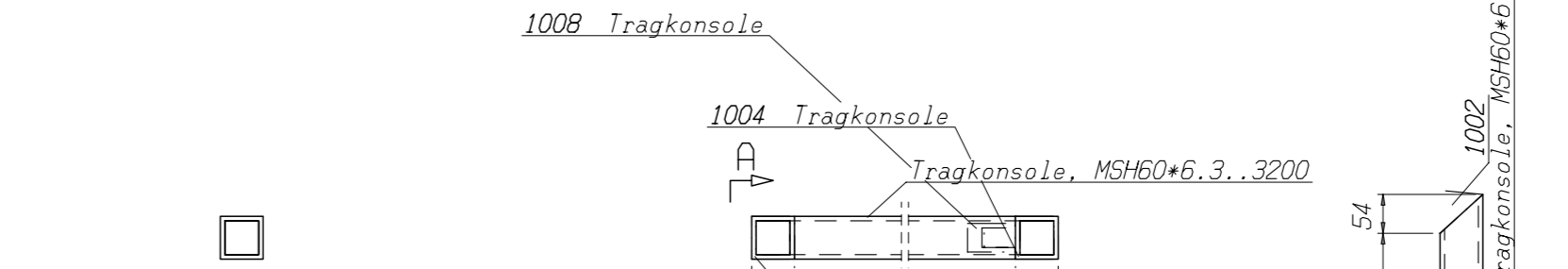
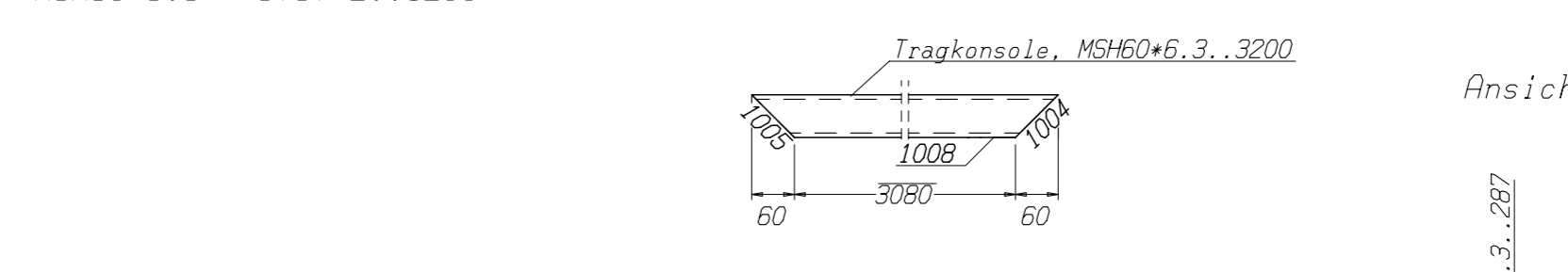
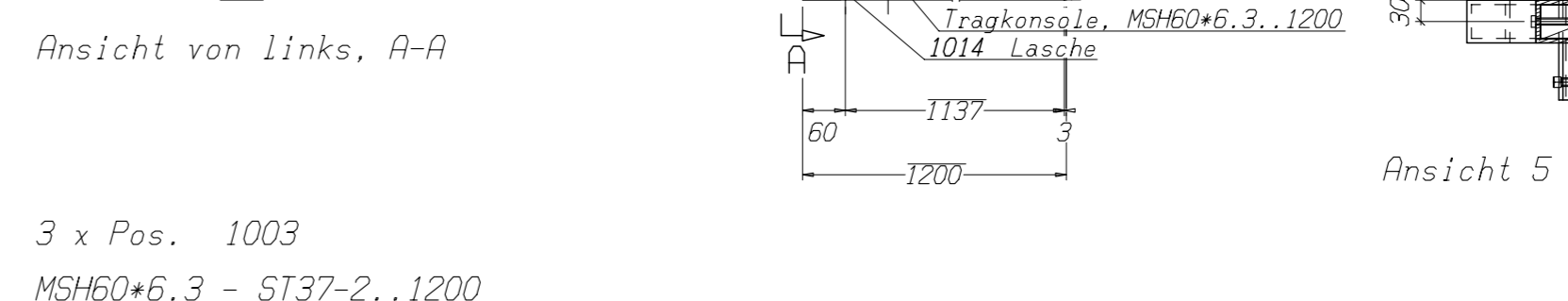
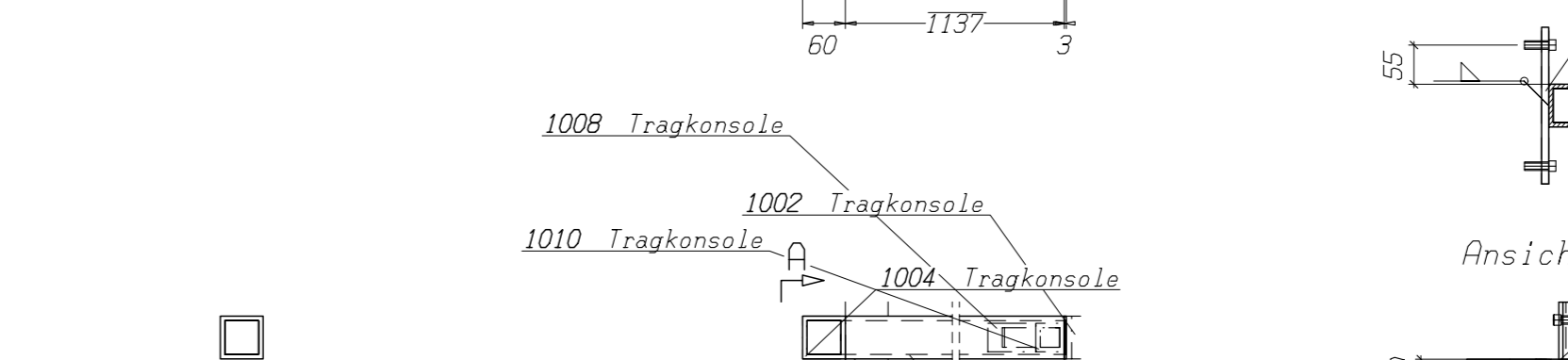

TS	Pos.	Stk.	Benennung	Profil	Material	Länge	Gewicht	Bem.
1	1	1	Längsträger vorne	IPE140	ST37-2	7670	98.94	

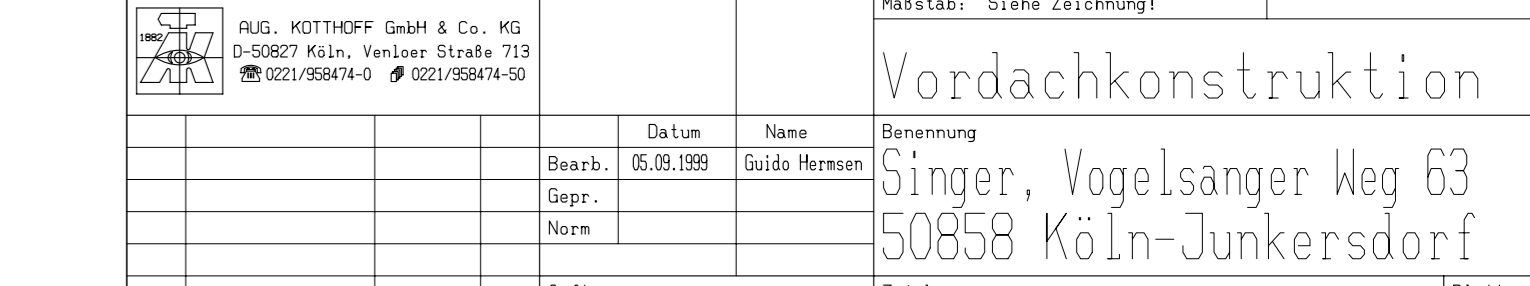
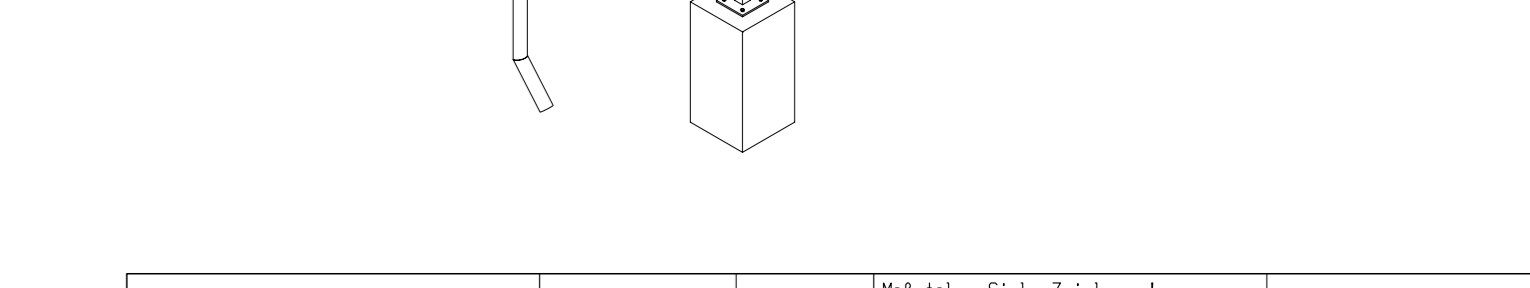
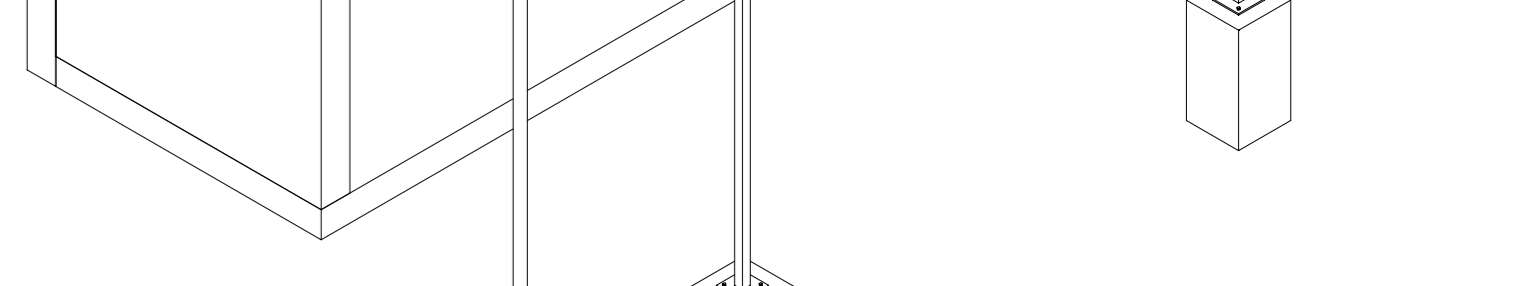
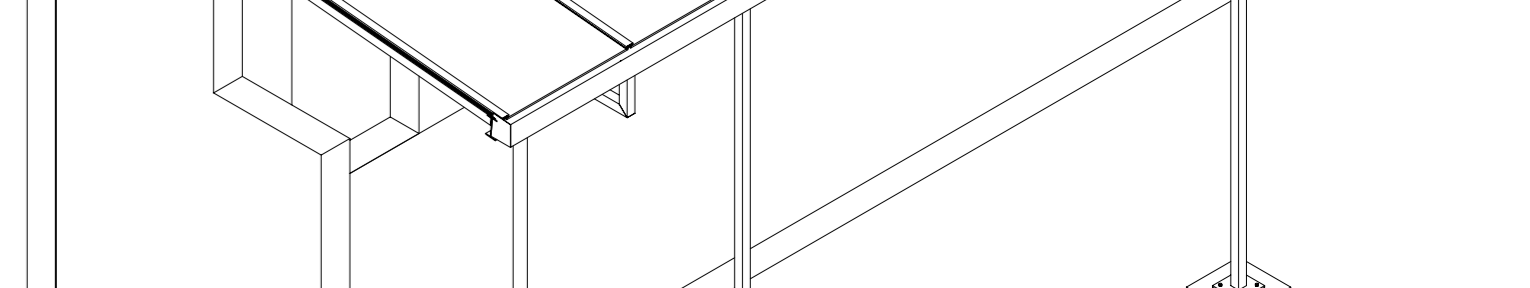
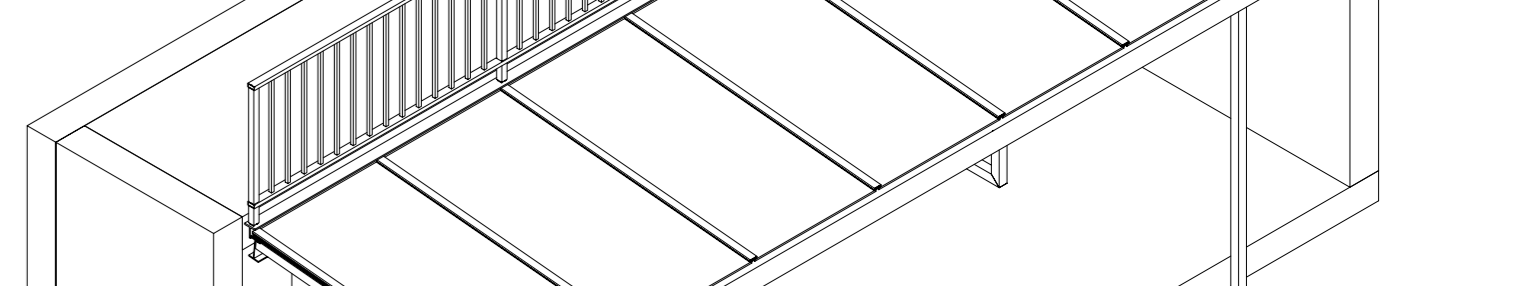
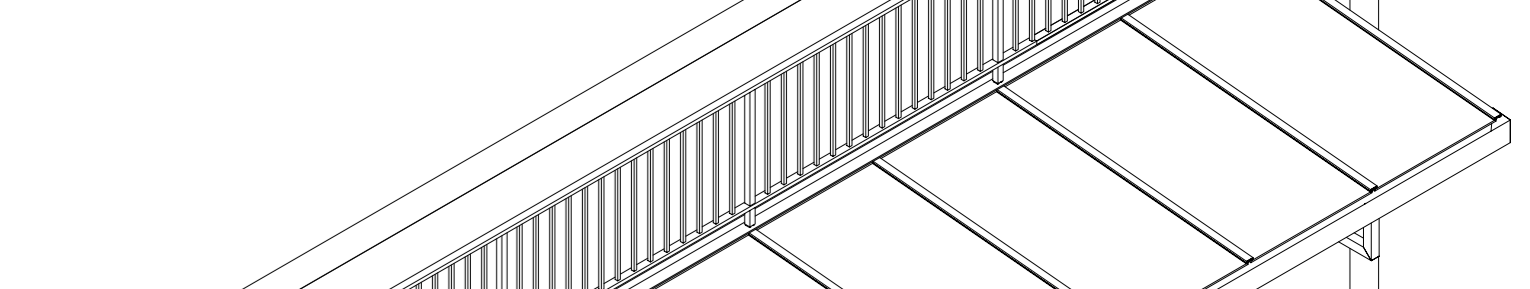
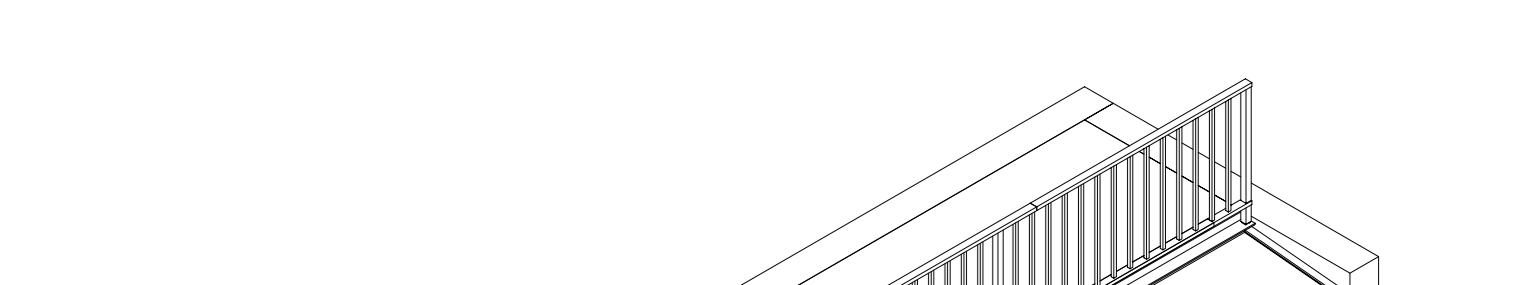
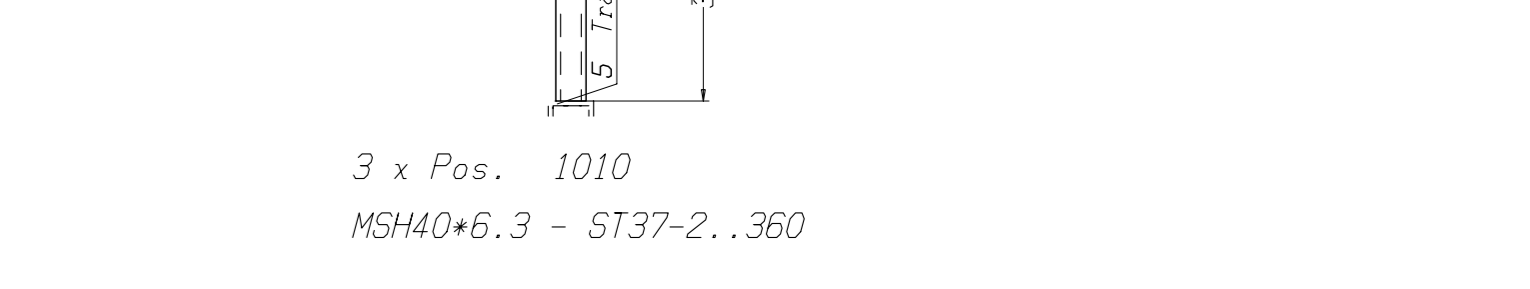
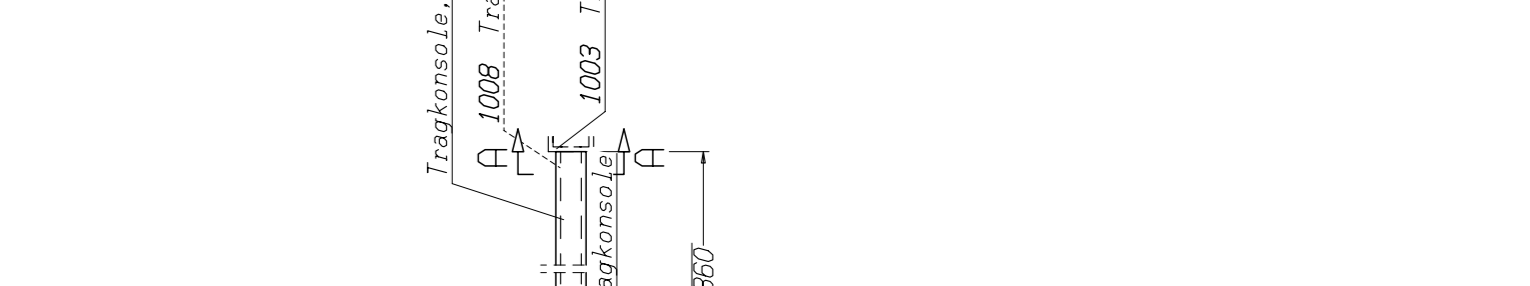
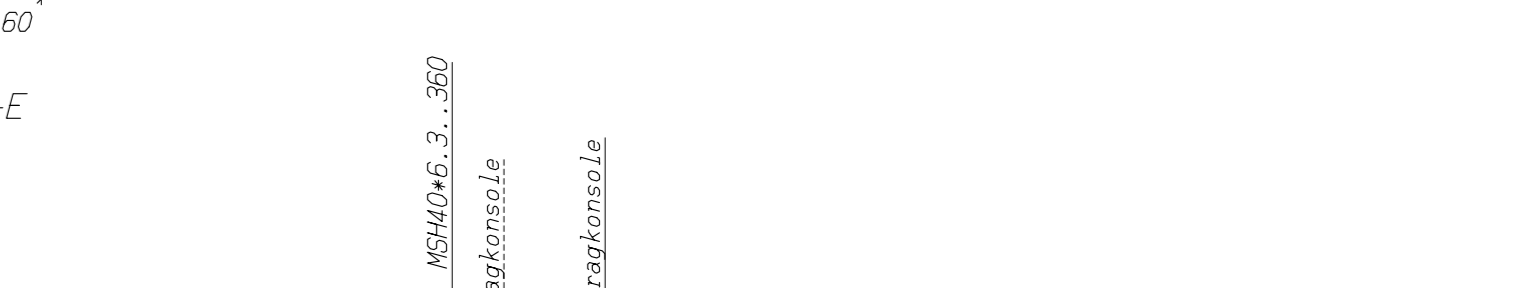
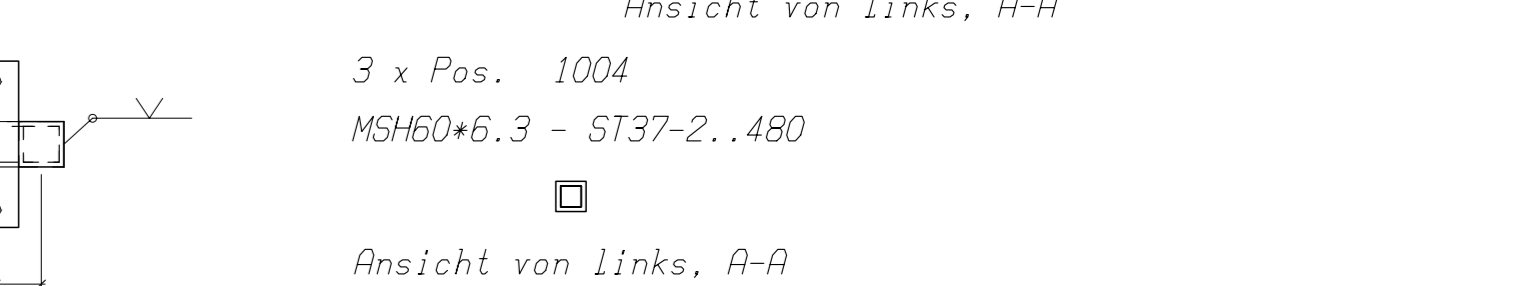
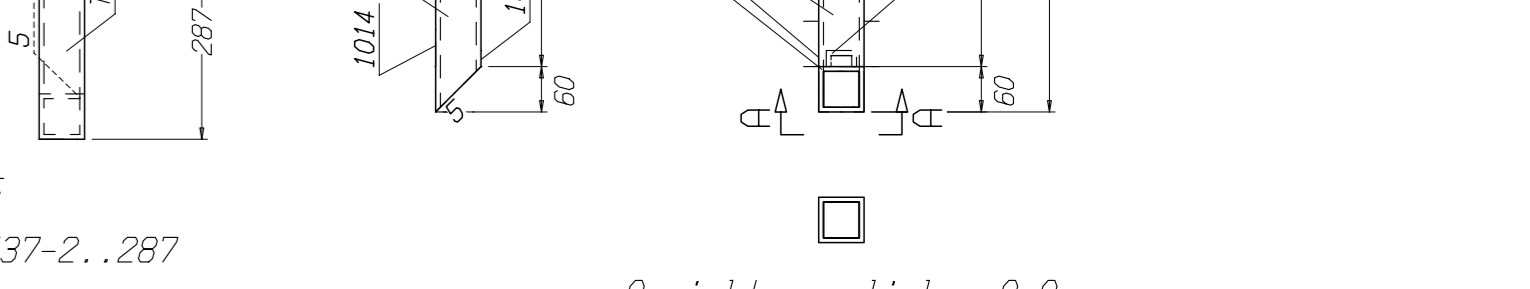
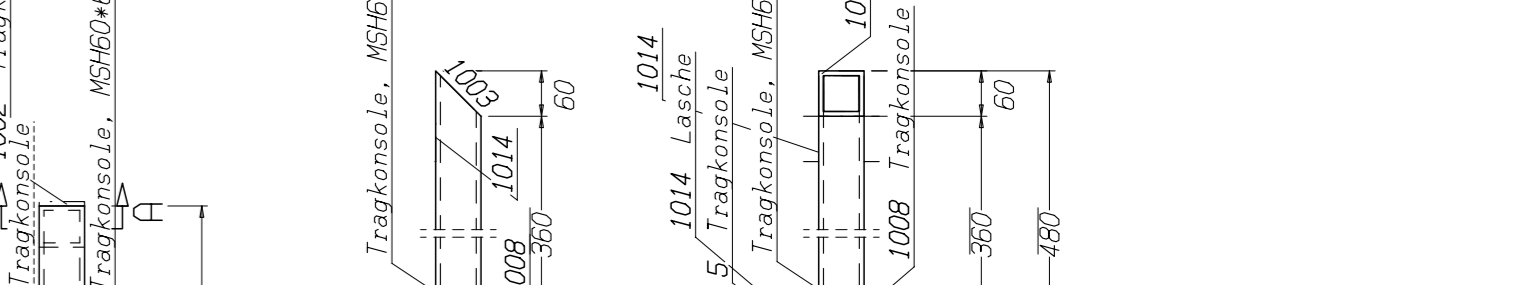
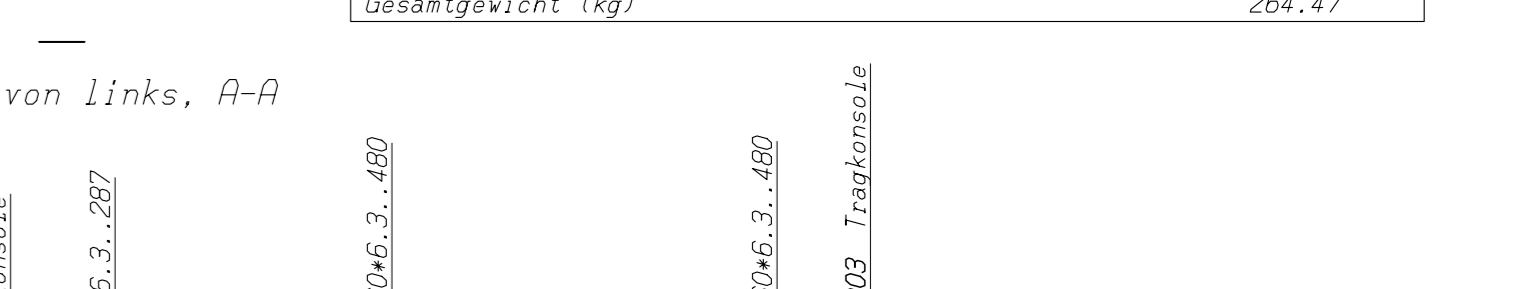
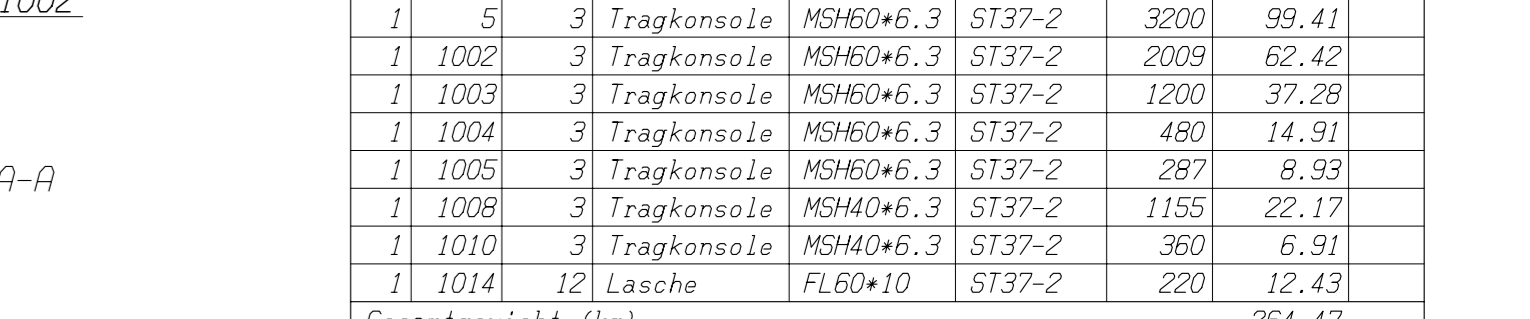
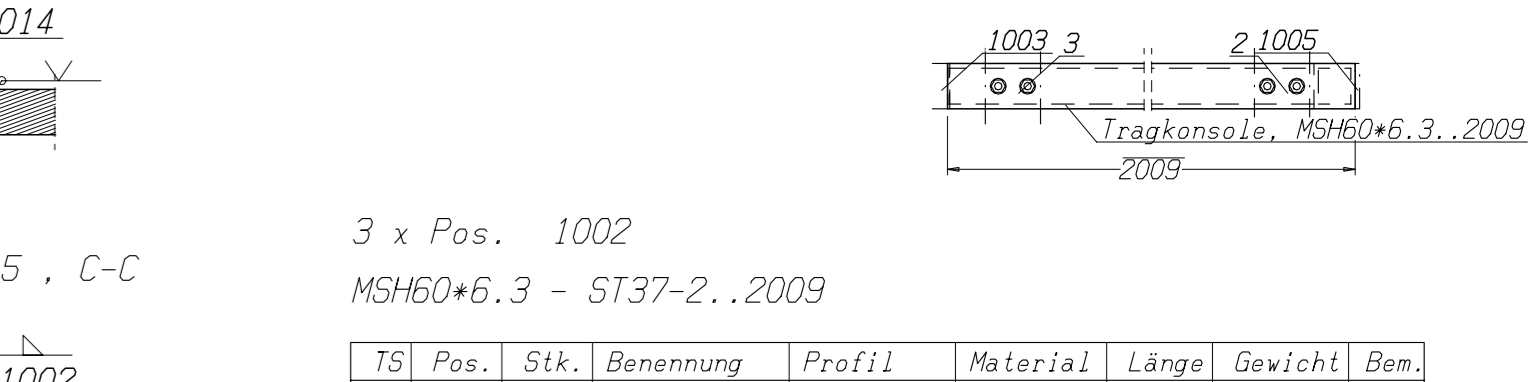

TS	Pos.	Stk.	Benennung	Profil	Material	Länge	Gewicht	Bem.
1	1	1	Längsträger vorne	IPE140	ST37-2	7670	98.94	

